



# LoadLIFTER 5000™

S E R I E S

Installation  
Guide



*Dodge/Ram 2500*

**Kits 57289 | 88289 | 89289**

For maximum effectiveness and safety, please read these instructions completely before proceeding with installation.

## IDENTIFYING THE DIFFERENCES BETWEEN KITS

Should you need to contact Air Lift customer service, you will need to know which kit you are inquiring about: standard LoadLifter 5000, LoadLifter 5000 Ultimate or LoadLifter 5000 Ultimate Plus. The kits are easily identifiable by looking at the roll plates and air lines.

- Standard **LoadLifter 5000** — Zinc-plated steel roll plates and black nylon air lines.
- LoadLifter 5000 Ultimate** — Black powder-coated roll plates and black nylon air lines.
- LoadLifter 5000 Ultimate Plus** — Stainless steel roll plates, braided stainless steel air lines, stainless steel air spring mounting hardware.



LoadLifter 5000  
silver zinc-plated steel  
roll plate



LoadLifter 5000 Ultimate  
black powder-coated  
roll plate



LoadLifter 5000 Ultimate Plus  
stainless steel  
roll plate



LoadLifter 5000  
nylon air line



LoadLifter 5000 Ultimate  
nylon air line



LoadLifter 5000 Ultimate PLUS  
braided stainless steel air line

Air Lift offers two Ultimate Plus upgrade kits:

**52300** - Braided stainless steel air line and fittings.

**52301** - Stainless steel roll plates, air spring mounting hardware, braided stainless steel air lines and fittings.

# TABLE OF CONTENTS

<b>Installation Diagram</b> . . . . .	<b>2</b>
<b>Hardware and Tools Lists</b> . . . . .	<b>3</b>
<b>Introduction</b> . . . . .	<b>4</b>
Notation Explanation . . . . .	4
Maintenance and Use Guidelines . . . . .	4
Limited Warranty and Return Policy . . . . .	4
<b>Installing the LoadLifter 5000 Series System</b> . . . . .	<b>5</b>
Getting Started . . . . .	5
Building the Air Spring Assemblies . . . . .	7
Finished Assemblies . . . . .	9
Attaching the Assemblies to the Frame . . . . .	9
<b>Installing the Air Lines</b> . . . . .	<b>11</b>
Installing Nylon Air Lines . . . . .	11
Installing Braided Stainless Steel Air Lines . . . . .	12
<b>Finished Installation Photos</b> . . . . .	<b>13</b>
Installation Checklist . . . . .	13

# Installation Diagram

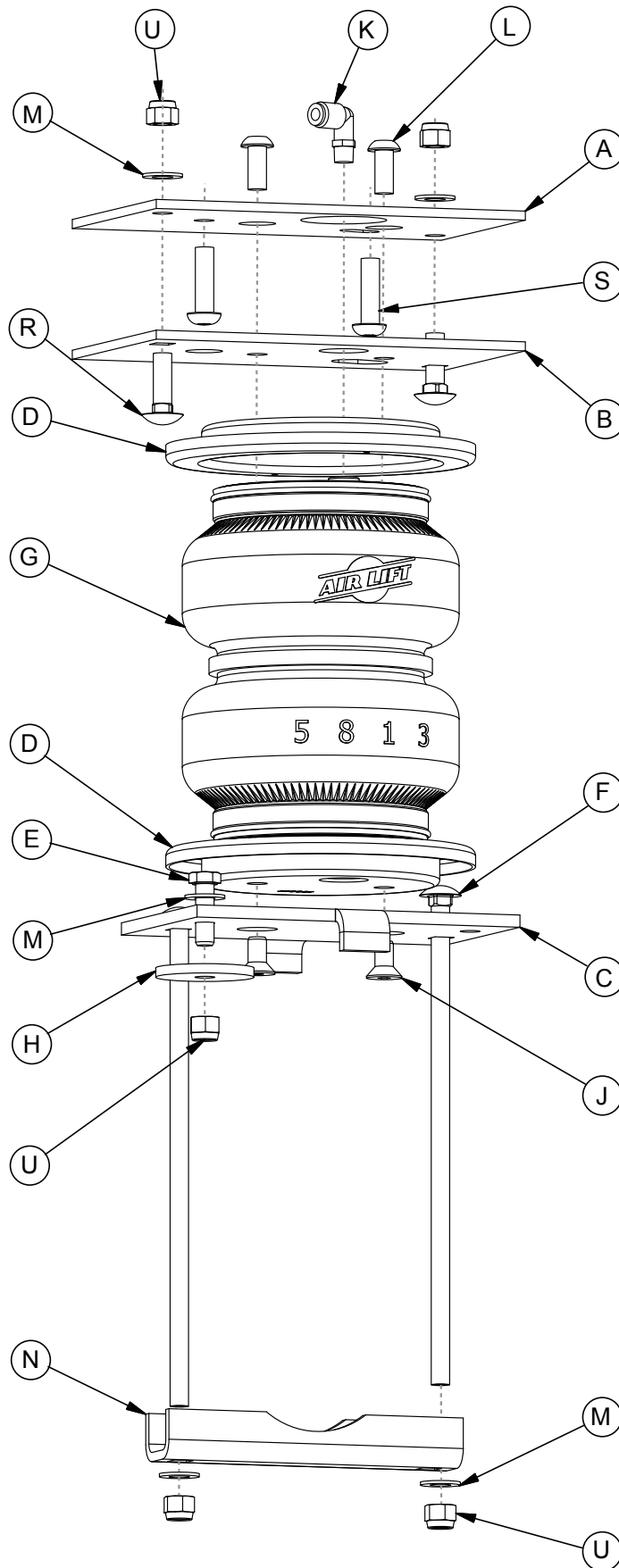

fig. 1



# Hardware and Tools Lists

## Common Parts Included in All 3 Kits

Item	Part#	Description	Qty
A	07160	Upper frame bracket	2
B	07161	Upper air spring bracket	2
C	03019	Lower bracket	2
E	17188	3/8"-16 x 1 1/4" Hex-head bolt	2
F	17387	3/8"-16 x 10" Carriage bolt	4
H	18260	Large flat washer	2
M	18444	3/8" Flat washer	10
N	01531	Clamp bar	2
R	17361	3/8"-16 x 1 1/4" Carriage bolt	4
S	17366	M10-1.5 Button-head screw	4
U	18435	3/8"-16 Nylon lock nut	10
DD*	18501	M8 stainless steel flat washer	2
EE*	21234	Rubber washer	2
FF*	18411	Stainless steel star washer	2

\* not pictured in the Installation Diagram

## TOOLS LIST

Description	Qty
Standard and metric open-end or box wrenches	SET
Ratchet	1
Standard and metric, regular and deep-well sockets	SET
5/16" drill bit (very sharp)	1
9/16" Crows foot adapter	1
Heavy-duty drill	1
Torque wrench	1
Standard and metric hex-key wrenches	1
Hose cutter, razor blade or sharp knife	1
Hoist or floor jacks	1
Safety stands	2
Safety glasses	1
Air compressor or compressed air source	1
Spray bottle with dish soap/water solution	1

The photos in this manual show the LoadLifter 5000 Ultimate kit.

## Unique Parts in Each Kit

### LoadLifter 5000™ KIT 57289

Item	Part#	Description	Qty
D	11951	Roll plate (silver zinc plated)	4
G	58437	Air spring	2
J	17215	3/8"-24 x 3/4" Flat-head screw	4
K	21837	Push-to-connect (PTC) fitting	2
L	17365	3/8"-24 x 7/8" Button-head screw	4
AA*	20086	Nylon air line	1
BB*	10466	Zip tie	6
CC*	21230	Valve cap	2
GG*	21233	5/16" Hex nut	4

### LoadLifter 5000™ ULTIMATE KIT 88289

Item	Part#	Description	Qty
D	11967	Roll plate (black powder coated)	4
G	58496	Air spring with jounce bumper	2
J	17215	3/8"-24 x 3/4" Flat-head screw	4
K	21837	Push-to-connect (PTC) fitting	2
L	17365	3/8"-24 x 7/8" Button-head screw	4
AA*	20086	Nylon air line	1
BB*	10466	Zip tie	6
CC*	21230	Valve cap	2
GG*	21233	5/16" Hex nut	4

### LoadLifter 5000™ ULTIMATE PLUS+ KIT 89289

Item	Part#	Description	Qty
D	11880	Roll plate (stainless steel)	4
G	58496	Air spring with jounce bumper	2
J	17363	3/8"-24 x 3/4" Stainless steel flat-head screw	4
K	21815	AN type fitting	2
L	17376	3/8"-24 x 7/8" Stainless steel button head screw	4
AA*	20987	Stainless steel braided air line	2
BB*	10466	Zip tie	12
HH*	21709	Fill valve with cap & nut	2
II*	21813	PTC to AN adapter fitting	2
JJ*	20084	Air line assembly	1



Missing or damaged parts? Call Air Lift customer service at (800) 248-0892 for a replacement part.

# Introduction

The purpose of this publication is to assist with the installation and maintenance of the standard LoadLifter 5000 series air spring kits. All LoadLifter 5000 series kits utilize sturdy, reinforced, commercial-grade single or double, depending on the kit, convolute bellows. LoadLifter 5000 Ultimate kits add internal jounce bumpers and black powder-coated roll plates. LoadLifter 5000 Ultimate Plus kits also have internal jounce bumpers, but add stainless steel roll plates, air lines and air spring mounting hardware.

The air springs are manufactured like a tire with layers of rubber and cords that control growth. LoadLifter 5000 series kits are available for most 1/2-, 3/4- and 1-ton vehicles with leaf springs and provide up to 5,000 pounds (2,268kg) of load-leveling support with air adjustability from 5-100 PSI (.34-7BAR).

It is important to read and understand the entire installation guide before beginning installation or performing any maintenance, service or repair.

## NOTATION EXPLANATION

Hazard notations appear in various locations in this publication. Information which is highlighted by one of these notations must be observed to help minimize risk of personal injury or possible improper installation which may render the vehicle unsafe. Notes are used to help emphasize areas of procedural importance and provide helpful suggestions. The following definitions explain the use of these notations as they appear throughout this guide.

 **DANGER**

INDICATES IMMEDIATE HAZARDS WHICH WILL RESULT IN SEVERE PERSONAL INJURY OR DEATH.

 **WARNING**

INDICATES HAZARDS OR UNSAFE PRACTICES WHICH COULD RESULT IN SEVERE PERSONAL INJURY OR DEATH.

 **CAUTION**

INDICATES HAZARDS OR UNSAFE PRACTICES WHICH COULD RESULT IN DAMAGE TO THE MACHINE OR MINOR PERSONAL INJURY.

## MAINTENANCE AND USE GUIDELINES

Minimum Recommended Pressure	Maximum Air Pressure
<b>5 PSI (.34BAR)</b>	<b>100 PSI (7BAR)</b>

1. Check air pressure weekly.
2. Always maintain normal ride height. Never inflate beyond 100 PSI (7BAR).
3. If the system develops an air leak, use a soapy water solution to check all air line connections and the inflation valve core before deflating and removing the air spring.

 **CAUTION**

FOR SAFETY AND TO PREVENT POSSIBLE DAMAGE TO THE VEHICLE, DO NOT EXCEED MAXIMUM GROSS VEHICLE WEIGHT RATING (GVWR) OR PAYLOAD RATING, AS INDICATED BY THE VEHICLE MANUFACTURER.

 **CAUTION**

ALTHOUGH THE AIR SPRINGS ARE RATED AT A MAXIMUM INFLATION PRESSURE OF 100 PSI (7BAR), THE AIR PRESSURE ACTUALLY NEEDED IS DEPENDENT ON LOAD AND GROSS VEHICLE WEIGHT RATING.

## LIMITED WARRANTY AND RETURN POLICY

Air Lift Company provides a limited lifetime warranty to the original purchaser of its load support products, that the products will be free from defects in workmanship and materials when used on cars and trucks as specified by Air Lift Company and under normal operating conditions, subject to the requirements and exclusions set forth in the full Limited Warranty and Return Policy that is available at [www.airliftcompany.com/warranty](http://www.airliftcompany.com/warranty).

For additional warranty information contact Air Lift Company customer service.

# Installing the LoadLifter 5000 Series System

## GETTING STARTED

1. Raise the vehicle and support the frame with safety stands, drop the axle down to make room for the air spring assemblies to be put into position between the frame and axle (Fig. 2).

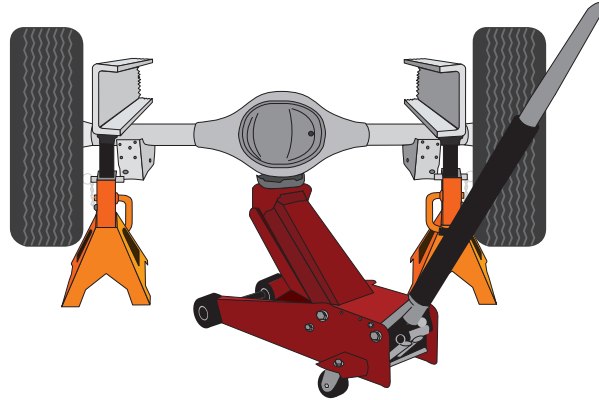

*fig. 2*

2. On the left (driver's) side axle there is a small vent tube (Fig. 3) that needs to be tied on an angle with a zip tie (BB).

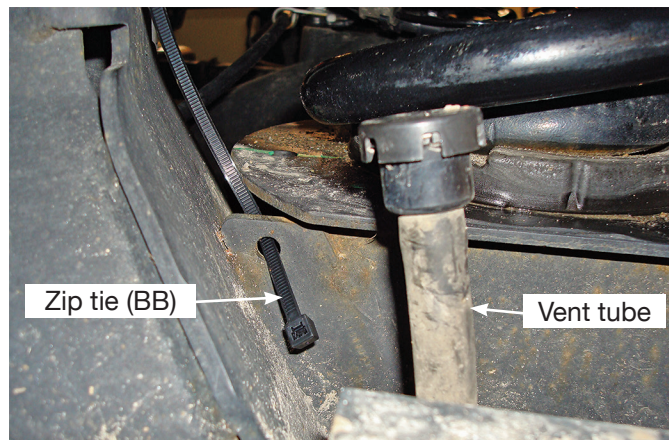

*fig. 3*

3. Insert the zip tie into the small hole in the lower coil spring seat, then around the vent tube and just snug the zip tie enough to angle the tube out of the way (Fig. 4).

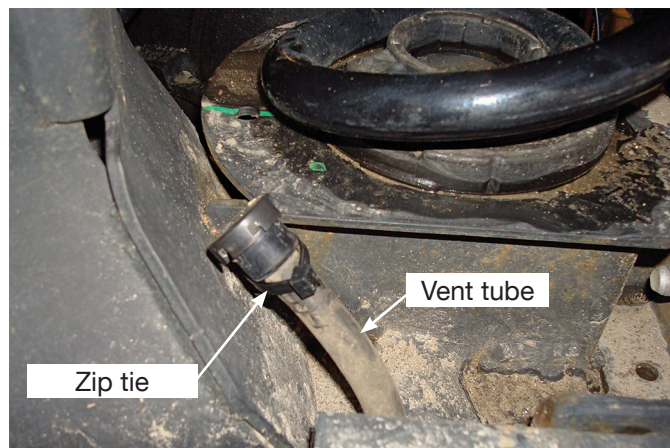

*fig. 4*

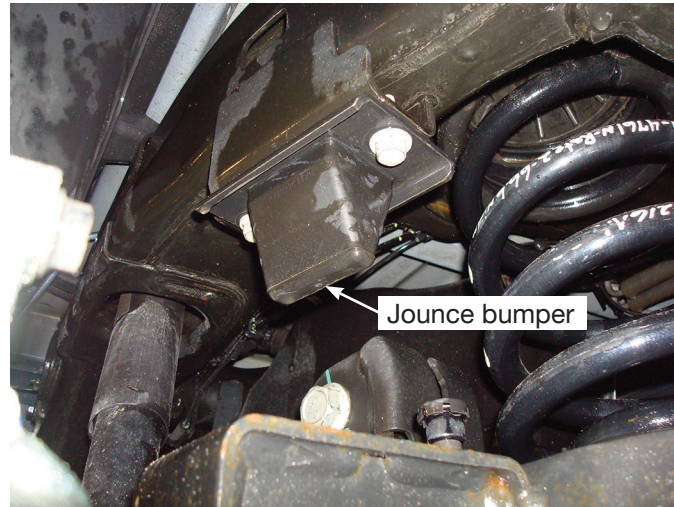
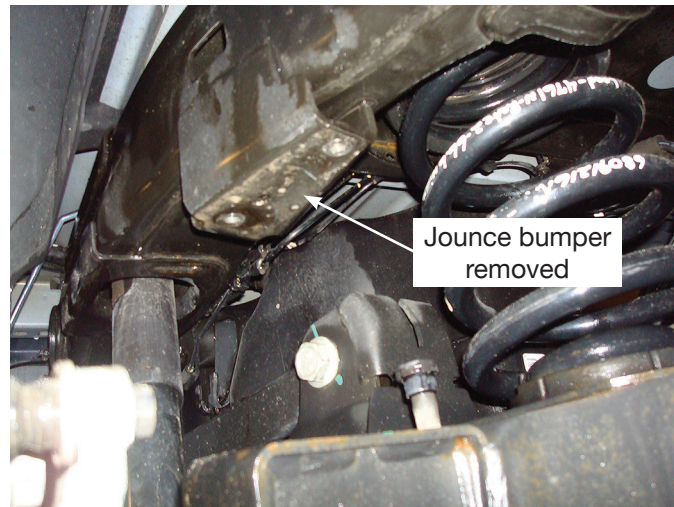

- Remove the left and right side jounce bumpers (Figs. 5 & 6).

*fig. 5*

*fig. 6*

- Attach the upper frame bracket (A) to the frame (Figs. 7 & 8) using the M10 button head screws (S).

**NOTE**

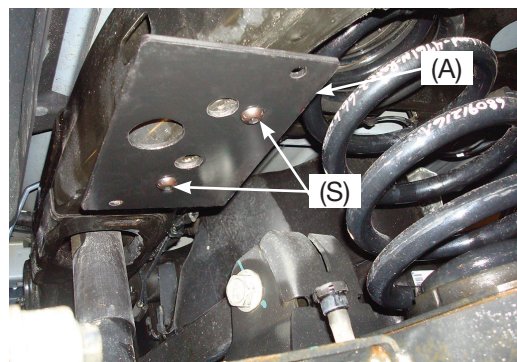
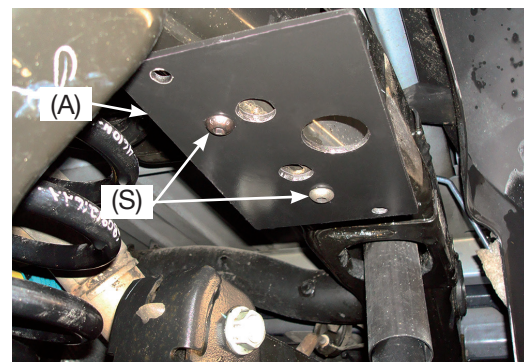
*The large hole in the bracket goes to the outside of the frame (toward the tire).*

**Driver's side**

*fig. 7*
**Passenger's side**

*fig. 8*

- Torque the mounting hardware to 30 lb.-ft. (41Nm).

## BUILDING THE AIR SPRING ASSEMBLIES

1. Set a roll plate (D) over the top of each air spring (G).

**NOTE**

*The radiused (rounded) edge of the roll plate (D) will be toward the air spring so that the air spring is seated inside both roll plates.*

2. Install the swivel fitting (K) into the top of the air spring finger tight plus one and a half turns (Fig. 9). Repeat for both air springs.

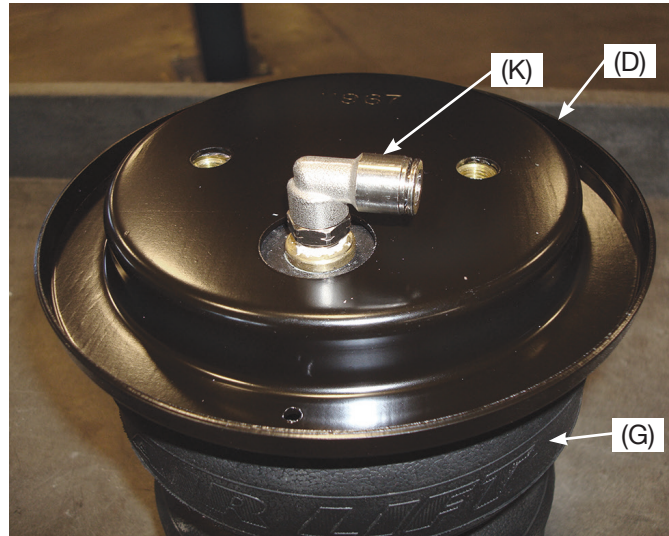

*fig. 9*

3. Set both air springs in front of you with the fittings pointing at you (Fig. 10).
4. Insert the 3/8" carriage bolt (R) through the upper air spring bracket (B) in the hole at the back side only (Figs. 1 & 10).

**NOTE**

*The upper air spring brackets will be a mirror image when set onto the air springs (see Fig. 10).*

Left (driver's)  
side assembly

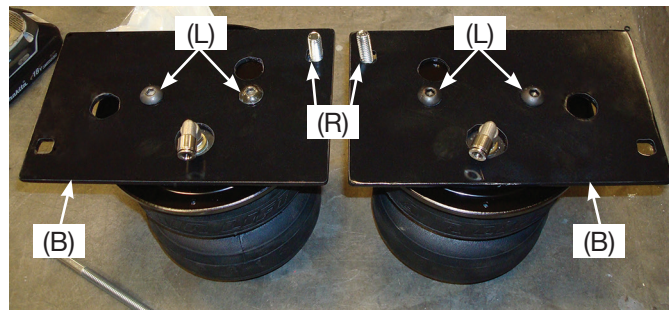

Right  
(passenger's)  
side  
assembly

*fig. 10*

5. Set both brackets onto the air springs and attach using the 3/8" button head screws (L). Torque no more than 20 lb.-ft. (27Nm).



6. Install the large flat washer (H) onto the lower bracket (C) with 3/8" hex-head bolt (E), 3/8" flat washer (M) and 3/8" nylon lock nut (U) as shown (Figs. 1 & 11). Tighten securely.
7. Insert the long 3/8" carriage bolts (F) into the square holes in the lower bracket (Figs. 1 & 11).

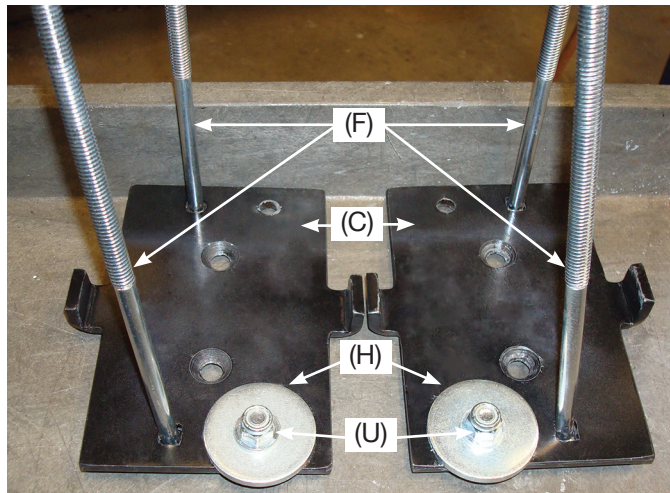
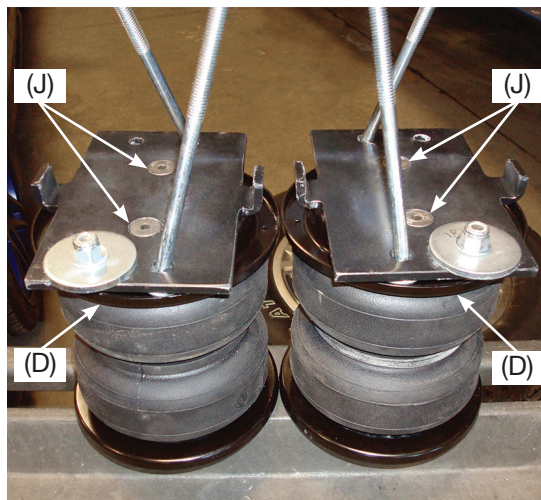

*fig. 11*

8. Set a roll plate (D) over the bottom of the air spring and install the lower brackets onto the air spring assembly so that the large washer previously installed will be forward of the axle once installed (Figs. 12 & 13) using the 3/8" flat head screws (J). Torque to no more than 20 lb.-ft. (27Nm).

Left (driver's) side assembly

*fig. 12*

Left (driver's) side assembly



Right (passenger's) side assembly

*fig. 13*

## FINISHED ASSEMBLIES

Left (driver's)  
side assembly



Right  
(passenger's)  
side assembly

*fig. 14*

## ATTACHING THE ASSEMBLIES TO THE FRAME

1. With the axle slightly hanging, set the left (driver's) side assembly on the axle, making sure that the carriage bolt (F) goes in between the brake line and the axle (Fig. 15).



*fig. 15*

2. Carefully set the upper air spring bracket into position, making sure that the carriage bolt and fitting line up with the holes in the frame bracket (Fig. 16). Raise the axle up so that the brackets come together making sure the fitting and the carriage bolt go through the holes and do not bind.



*fig. 16*



3. Insert the remaining carriage bolt (R) through the open front holes from the bottom up and cap both upper carriage bolts with 3/8" flat washer (M) and 3/8" nylon lock nut (U). Torque to 16 lb.-ft. (22Nm). Repeat for the other side.

**NOTE**

*It may be necessary to use a 9/16" crows foot adapter to torque the nut underneath the frame.*

4. Bring the axle all the way up and position the lower bracket over the lower jounce bumper strike plate. The large washer on the bottom of the bracket should be positioned forward and over the lower jounce bumper strike plate (Fig. 17).

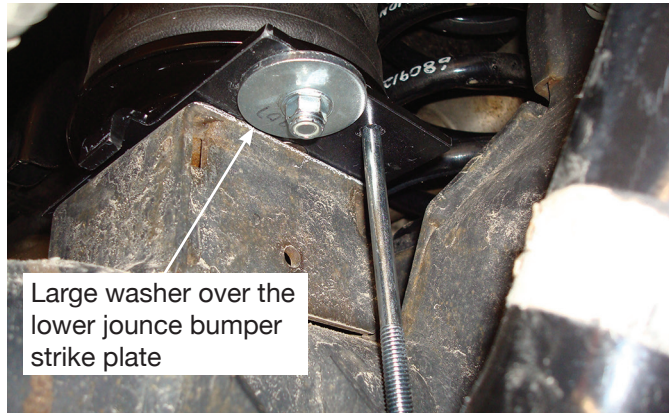

Large washer over the lower jounce bumper strike plate

Right  
(passenger's)  
side assembly

*fig. 17*

5. Set the clamp bar (N) over the two long carriage bolts (F) under the axle and cap with two 3/8" flat washers (M) and 3/8" nylon lock nuts (U) (Fig. 18).

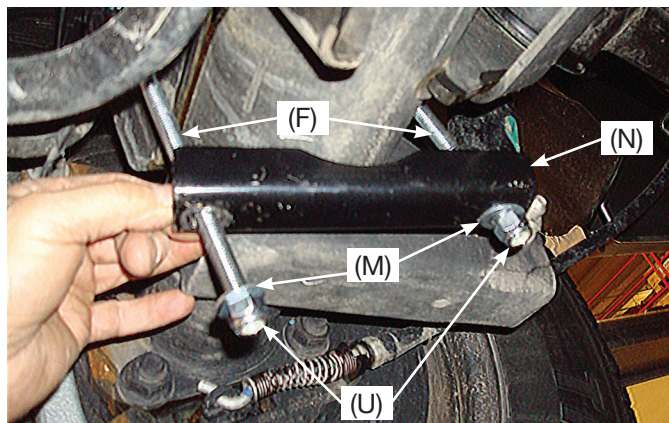

*fig. 18*

6. Torque evenly to 10 lb.-ft. (14Nm) (Fig. 19). Repeat for the other side.

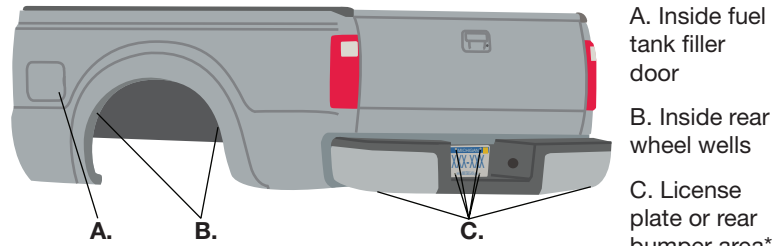

*fig. 19*

7. Raise the axle or lower the vehicle and remove the safety stands.

# Installing the Air Lines

Air lines are routed from the air springs to Schrader valves. LoadLifter 5000 series air lines come in two styles: nylon and braided stainless steel. Begin by choosing locations for the Schrader valves and drill a 5/16" (8mm) hole, if necessary (Fig. 20).



\* For LoadLifter 5000 Ultimate Plus kits, the recommended location for the Schrader valves is the rear bumper area or license plate.

fig. 20



KEEP AT LEAST 6" (150MM) OF CLEARANCE BETWEEN ALL AIR LINES AND THE EXHAUST SYSTEM. AVOID SHARP BENDS AND EDGES.

## INSTALLING NYLON AIR LINES

1. Cut the air line in half. Make clean, square cuts with a razor blade or hose cutter (Fig. 21). Do not use scissors or wire cutters.

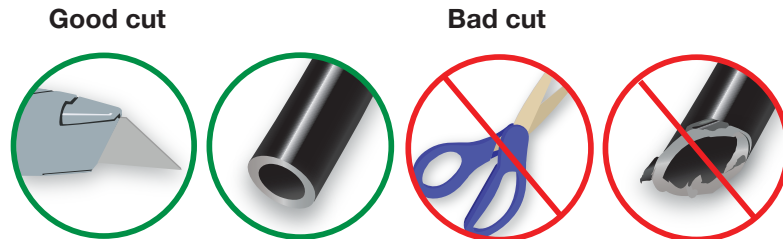

fig. 21

2. Use zip ties to secure the air line to fixed points along the chassis. Do not pinch or kink the air line. The minimum bend radius for the air line is 1" (25mm). Leave at least 2" (50mm) of slack in the air line to allow for any movement that might pull on the air line.
3. Install the Schrader valve in the chosen location (Fig. 22).

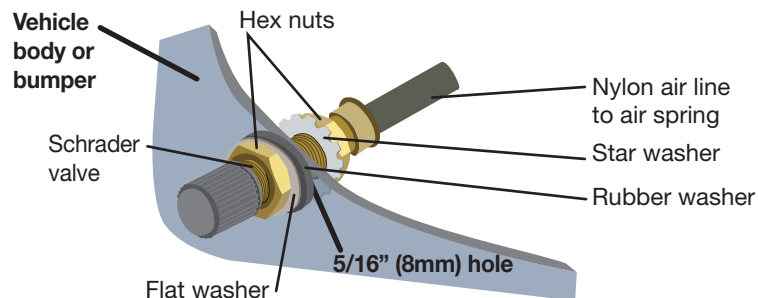

fig. 22

## INSTALLING BRAIDED STAINLESS STEEL AIR LINES

**CAUTION**

KEEP THE AIR LINE AWAY FROM THE FUEL LINE, BRAKE LINES AND ELECTRICAL WIRES.

1. Use zip ties to secure the air line to fixed points along the chassis every 6" to 8" (150-200mm). Leave at least 2" (50mm) of slack to allow for any movement that might pull on the air line.
2. Tighten the air line hex nut finger tight, then use 2 wrenches to turn 1 additional flat (1/6 of one full turn). **Do not overtighten** (Figs. 23 or 24). The easiest way to tighten the fitting is off the vehicle. Install the Schrader valve in the chosen location.
3. Coil and secure any excess air line in an area where it will not be susceptible to damage. The braided stainless steel air line cannot be trimmed.

### Air Line Setup Without Compressor System

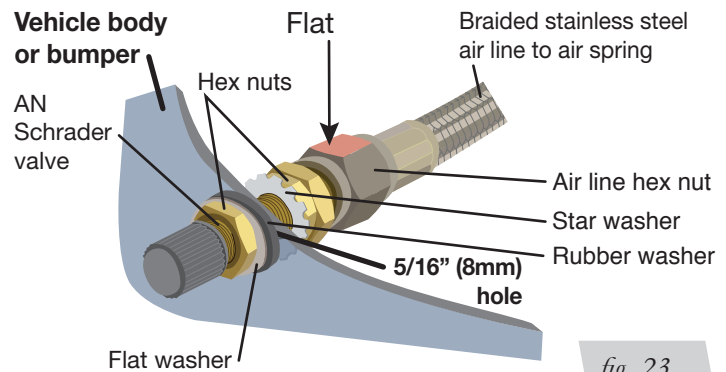

*fig. 23*

### Air Line Setup for Compressor Integration

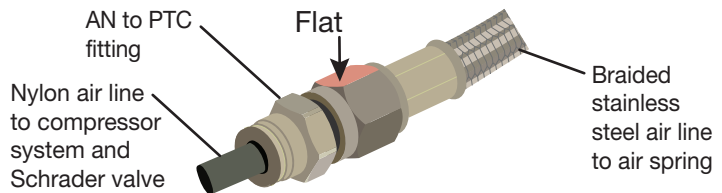

*fig. 24*



# Finished Installation Photos

1. The following images show the finished installation of both sides. (Figs. 25-28).



Left (driver's) side top view

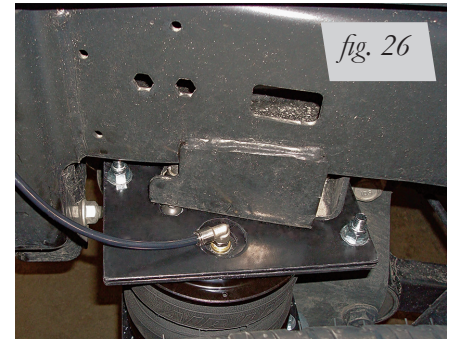

Right (passenger's) side top view

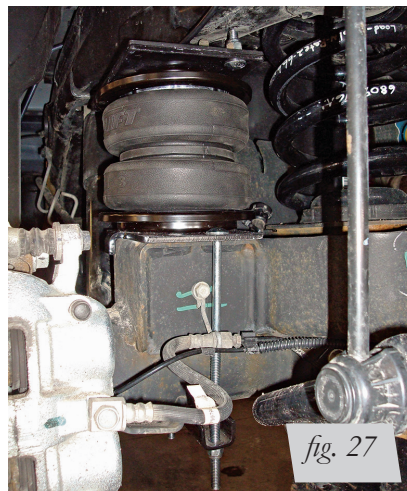

Left (driver's) side back view shown with tire removed



Right (passenger's) side view shown with tire removed

## INSTALLATION CHECKLIST

- Clearance test** — Inflate the air springs to 40-60 PSI (2.8-4.1BAR) and make sure there is at least 1/2" (13mm) clearance from anything that might rub against each sleeve. Be sure to check the tire, brakes, frame, shock absorbers and brake cables.
- Leak test before road test** — Inflate the air springs to 40-60 PSI (2.8-4.1BAR) and check all connections for leaks. All leaks must be eliminated before the vehicle is road tested.
- Heat test** — Be sure there is sufficient clearance from heat sources, at least 6" (152mm) for air springs and air lines. If a heat shield was included in the kit, install it. If there is no heat shield, but one is required, call Air Lift customer service at **(800) 248-0892**.
- Fastener test** — Recheck all bolts for proper torque.
- Road test** — The vehicle should be road tested after the preceding tests. Inflate the springs to recommended driving pressures. Drive the vehicle 10 miles (16km) and recheck for clearance, loose fasteners and air leaks.
- Operating instructions** — If professionally installed, the installer should review the operating instructions with the owner. Be sure to provide the owner with all of the paperwork that came with the kit.



*Thank you for purchasing Air Lift Products – the Authorized Installer's choice!*

## **Need Help?**

Contact Air Lift Company Customer Service at (800) 248-0892  
or email [service@airliftcompany.com](mailto:service@airliftcompany.com).

For calls outside the U.S. or Canada, dial (517) 322-2144.



Air Lift Company • 2727 Snow Road • Lansing, MI 48917 or P.O. Box 80167 • Lansing, MI 48908-0167