

LoadLifter 5000™ SERIES + Air Lift® ProSeries



Installation Guide



** LoadLifter 5000 kit shown here*



Watch the video

Info on Table of Contents page

Ford SD F-250/F-350 4WD SRW (Single Rear Wheel)

Kits 57352 | 88352 | 93352

For maximum effectiveness and safety, please read these instructions completely before proceeding with installation.

Failure to read these instructions can result in an incorrect installation.

Protect your Air Lift Purchase by Completing your Warranty Registration

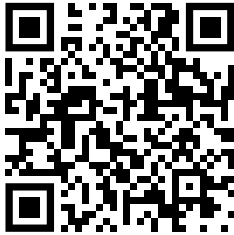

Thank you for purchasing an Air Lift load support product!

Take a photo of your sales receipt and then scan the QR code to complete your online warranty registration.

TABLE OF CONTENTS

2 System Overview

3 Hardware and Tools

4 Introduction

Notation Explanation

Identifying the Differences Between Kits

5 Install the System

Prepare the Vehicle

Assemble the Air Springs

Install the Air Spring Assemblies

12 Install the Air Lines

Install the Heat Shield

14 Finished Installation

15 Before Operating

Installation Checklist

Maintenance and Use Guidelines

16 Limited Warranty and Return Policy

Video-enhanced installation guides

Visit airliftcompany.com/workshop/category/install-videos to access our installation video archive*.

System Overview

Driver's
(left) Side

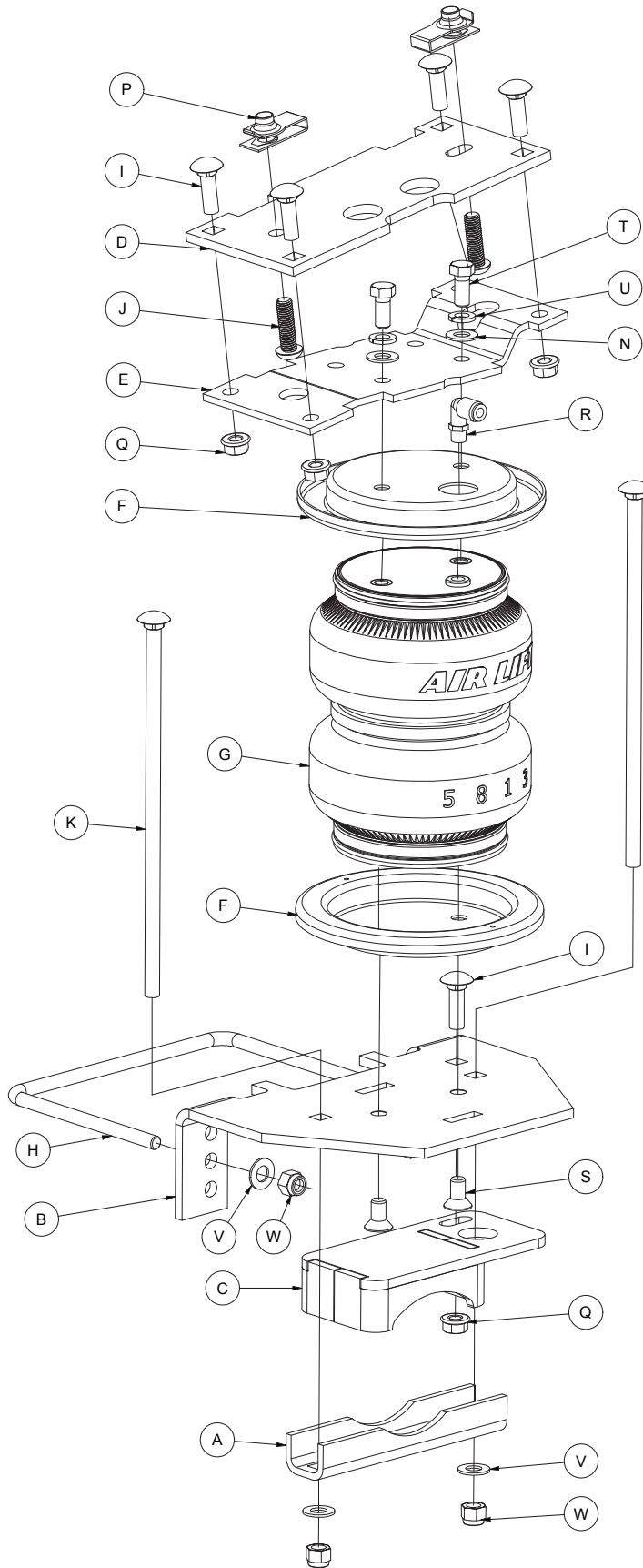

Fig. 1

Hardware and Tools

Common Parts Included in All 3 Kits

Item	Part#	Description	Qty
A	01531	Clamp bar	2
B	03066	Lower bracket, main plate	2
C	03224	Lower bracket, cup	2
D	07045	Upper bracket, frame.....	2
E	07220	Upper bracket, air spring	2
H	11770	U-bolt	2
I	17134	3/8"-16 x 1" Carriage bolt.....	10
J	17366	M10-1.5 x 35 Button-head cap screw	4
K	17387	3/8"-16 x 10" Carriage bolt.....	4
P	18622	M10-1.5 Universal nut.....	4
Q	18422	3/8"-16 Serrated flange lock nut.....	10
R	21837	Push-to-connect (PTC) fitting	2
V	18444	Flat washer.....	8
W	18435	3/8"-16 Nylon lock nut.....	8
AA*	20086	Air line assembly.....	1
BB*	10466	Zip ties.....	6
CC*	21230	Valve cap	2
DD*	18411	Star washer.....	2
EE*	21234	Rubber washer	2
FF*	18501	M8 Flat washer	2
GG*	21233	5/16" Hex nut	4
HH*	34924	Heat shield kit.....	1

* These parts are not shown in the System Overview (Fig.1).

TOOLS NEEDED

Description.....	Qty
Standard and metric open-end or box wrenches	SET
Ratchet	1
Standard and metric sockets.....	SET
5/16" drill bit (very sharp)	1
9/16" Crow's foot adapter	1
9/16" ratchet combo wrench.....	1
Heavy-duty drill	1
Torque wrench.....	1
Standard and metric hex-key wrenches	1
Flat-tip screwdriver.....	1
Hose cutter, razor blade, or sharp knife	1
Hoist or floor jacks	1
Safety stands.....	2
Safety glasses	1
Air compressor or compressed air source	1
Spray bottle with dish soap/water solution	1

The photos in this manual show the LoadLifter 5000 kit.

Unique Parts in Each Kit

LoadLifter 5000™ KIT 57352

Item	Part#	Description	Qty
F	11951	Roll plate (silver zinc plated)	4
G	58437	Air spring.....	2
N	18444	3/8" Flat washer	4
S	17215	3/8"-24 x 3/4" Flat-head socket-cap screw	4
T	17203	3/8"-24 x 7/8" Hex-cap screw	4
U	18427	3/8" Lock washer.....	4

LoadLifter 5000™ ULTIMATE KIT 88352

Item	Part#	Description	Qty
F	11967	Roll plate (black powder coat)	4
G	58496	Air spring w/ jounce bumper.....	2
N	18444	3/8" Flat washer	4
S	17215	3/8"-24 x 3/4" Flat-head socket-cap screw	4
T	17203	3/8"-24 x 7/8" Hex-cap screw	4
U	18427	3/8" Lock washer.....	4

Air Lift® ProSeries KIT 93352

Item	Part#	Description	Qty
F	11951	Roll plate (silver zinc plated)	4
G	58937	Air spring.....	2
N	18507	3/8" Stainless steel flat washer.....	4
S	17363	3/8"-24 x 3/4" Stainless FHSC screw.....	4
T	17284	3/8"-24 x 7/8" Stainless steel hex-cap screw.....	4
U	18504	3/8" Stainless steel lock washer	4
II*	21838	Tee fitting.....	1



Missing or damaged parts? Call Air Lift customer service at (800) 248-0892 for a replacement part.

Introduction

The purpose of this publication is to assist with the installation and maintenance of the LoadLifter 5000 series and Air Lift ProSeries air spring kits. All LoadLifter 5000 series and Air Lift ProSeries kits utilize sturdy, reinforced, commercial-grade single or double, depending on the kit, convolute bellows.

The air springs are manufactured like a tire with layers of rubber and cords that control growth. LoadLifter 5000 series and Air Lift ProSeries kits provide up to 5,000 pounds (2,268kg) of load-leveling support with air adjustability from 5-100 PSI (.34-7BAR).

It is important to read and understand the entire installation guide before beginning installation or performing any maintenance, service or repair.

NOTATION EXPLANATION

Hazard notations appear in various locations in this publication. Information highlighted by one of these notations must be observed to help minimize risk of personal injury or possible improper installation, which may render the vehicle unsafe. Notes are used to help emphasize areas of procedural importance and provide helpful suggestions. The following definitions explain the use of these notations as they appear throughout this installation guide.



INDICATES IMMEDIATE HAZARDS WHICH WILL RESULT IN SEVERE PERSONAL INJURY OR DEATH.



INDICATES HAZARDS OR UNSAFE PRACTICES WHICH COULD RESULT IN SEVERE PERSONAL INJURY OR DEATH.



INDICATES HAZARDS OR UNSAFE PRACTICES WHICH COULD RESULT IN DAMAGE TO THE MACHINE OR MINOR PERSONAL INJURY.



Used to help emphasize areas of procedural importance and provide helpful suggestions.

IDENTIFYING THE DIFFERENCES BETWEEN KITS

Should you need to contact Air Lift customer service, you will need to know which kit you are inquiring about: standard LoadLifter 5000, LoadLifter 5000 Ultimate or standard Air Lift ProSeries. The kits are easily identifiable by looking at the end caps on the air spring and the roll plates.

- Standard **LoadLifter 5000™** — Plastic end cap and Zinc-plated steel roll plates.
- LoadLifter 5000™ Ultimate** — Plastic end cap and Black powder-coated roll plates.
- Standard **Air Lift® ProSeries** — Aluminum end cap and Zinc-plated steel roll plates.



LoadLifter 5000
Plastic end cap



LoadLifter 5000
silver zinc-plated steel roll plate



LoadLifter 5000 Ultimate
Plastic end cap



LoadLifter 5000 Ultimate
black powder-coated roll plate



Air Lift ProSeries
Aluminum end cap



Air Lift ProSeries
silver zinc-plated steel roll plate

Install the System

PREPARE THE VEHICLE

1. Raise the vehicle and support it, using safety stands or equivalent, so that the axle can be safely lowered away from the frame. This needs to be done in order for the air spring assembly to be put into position between the axle and frame (Fig. 2).

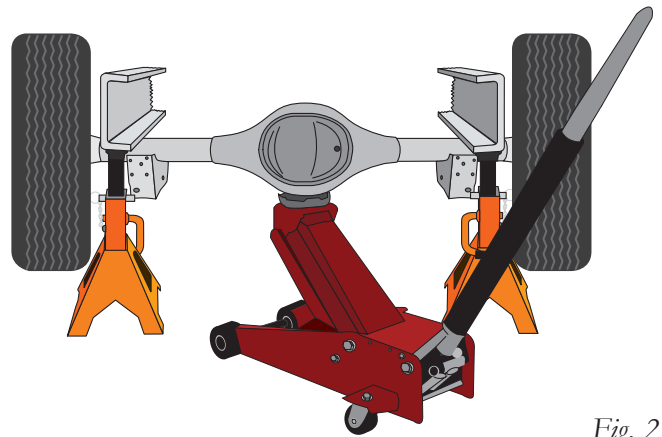

Fig. 2

2. Unbolt and remove the jounce bumper assembly from under the frame on both sides (Fig. 3).



Fig. 3

3. Remove the clip-in studs by prying on the hinged end with a screwdriver. Pull all four (two from each side) out from the frame (Fig. 4).

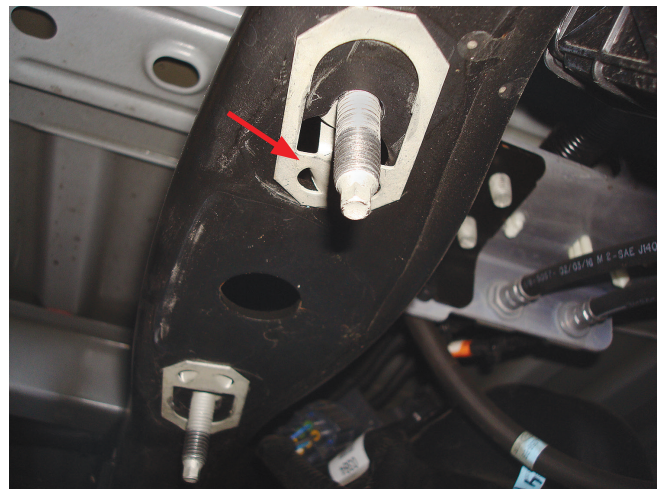

Fig. 4

4. Install the universal nuts (P) into the frame rail, lining up the holes in the frame and the threads in the nuts so that a bolt can be installed (Fig. 5).



A flat-tip screwdriver works well in installing the universal nut into position.

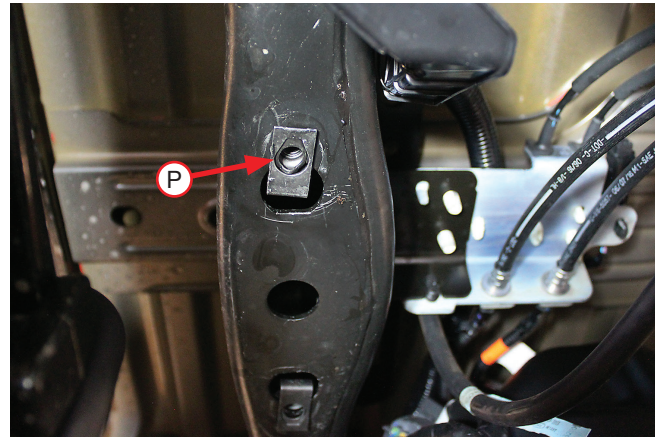

Fig. 5

5. Insert the 3/8"-16 x 1" carriage bolts (I) into the upper frame brackets (D). Install the upper bracket onto the frame using the M10-1.5 x 35mm button-head cap screws (J). The slot on the side of the bracket should be inboard of the frame rail (Fig. 6). The elongated hole should be toward the front of the truck (Fig. 7). Torque hardware to 38 lb.-ft. (52Nm).

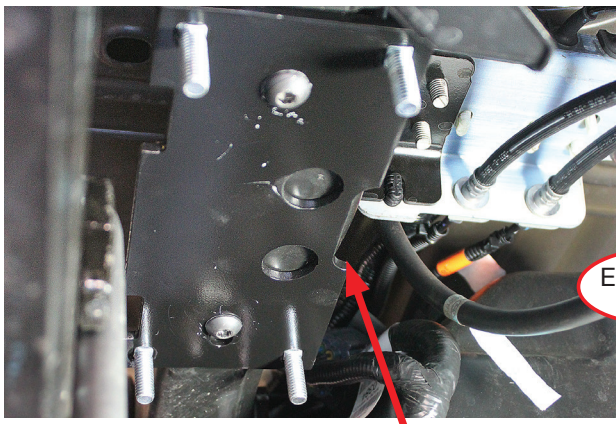

Fig. 6

This slot in the bracket goes inboard, away from leaf spring and tire

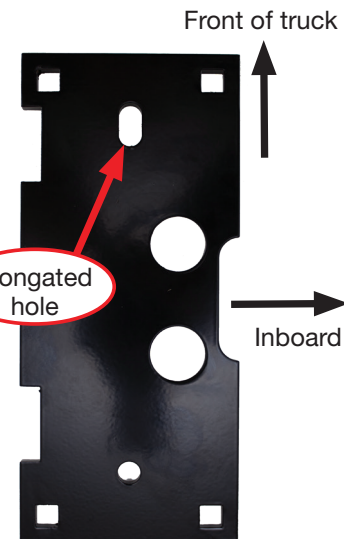

Fig. 7

ASSEMBLE THE AIR SPRINGS

1. Set a roll plate (F) on top of the air spring (G). The radiused, or rounded, edge of the roll plate should be toward the air spring so that it is seated inside the roll plate (Fig. 8). Install the 90-degree swivel fitting (R) into the port on top of the air spring finger-tight plus 1 1/2 turns.

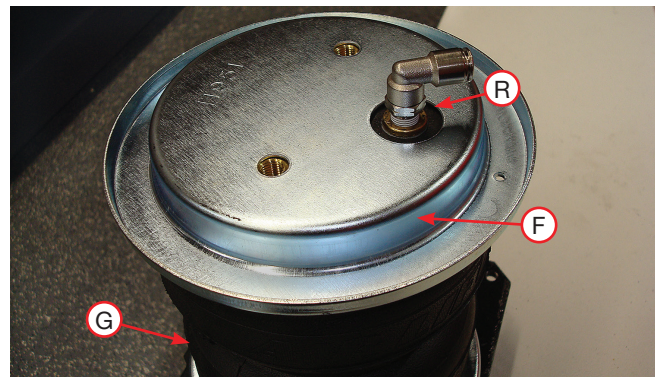

Fig. 8

- Set the upper air spring bracket (E) onto the top of the air spring using one set of holes with the 3/8"-24 x 7/8" hex-cap screw (T), 3/8" lock washer (U) and 3/8" flat washer (N) (Fig. 9). Install the remaining air spring bracket onto the remaining air spring, using the opposite holes from those that were previously used. This makes the air spring assemblies into left- and right-hand units. Torque the hardware to no more than 20 lb.-ft. (27Nm).

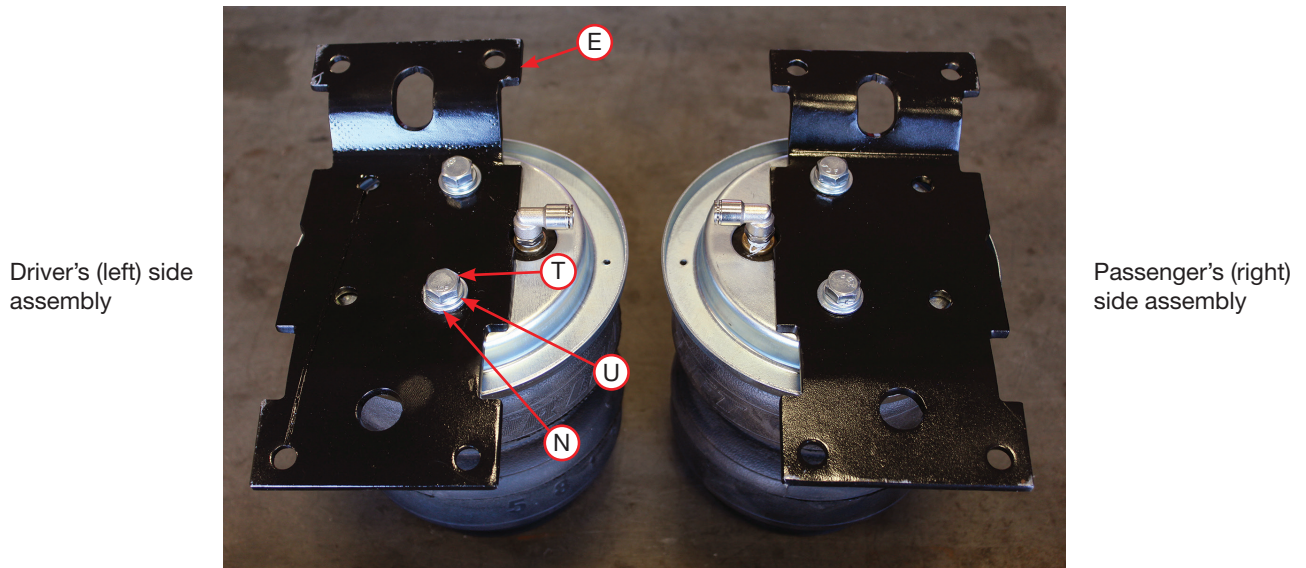

Fig. 9

- Flip the assemblies over and set a roll plate (F) onto the bottom of the air springs (Fig. 10).



Fig. 10

- Insert two 3/8"-16 x 10" carriage bolts (K) through the square holes in the lower bracket main plate (B) (Fig. 11).

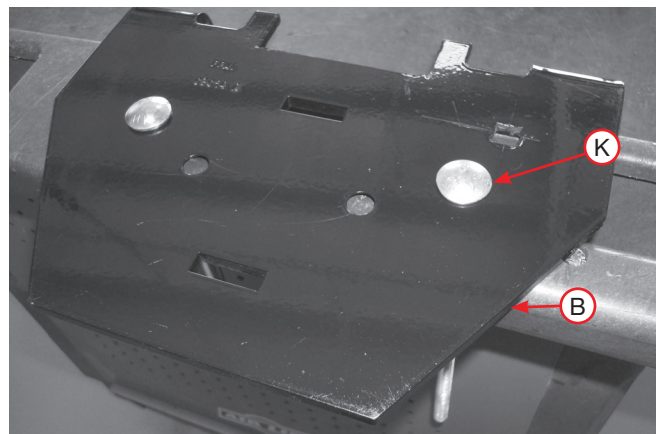

Fig. 11

- Set the lower bracket main plate assemblies onto the air springs with the roll plates installed. Attach with the 3/8"-24 x 3/4" flat-head socket-cap screws (S) (Fig. 12). Torque the hardware to no more than 20 lb.-ft. (27Nm).

NOTE The flange on the lower bracket must be on the opposite side of the fitting that is located on the top of the air spring.

The flanges on the lower bracket must be installed so they are on the opposite side of the fitting that is on the top of the air spring.

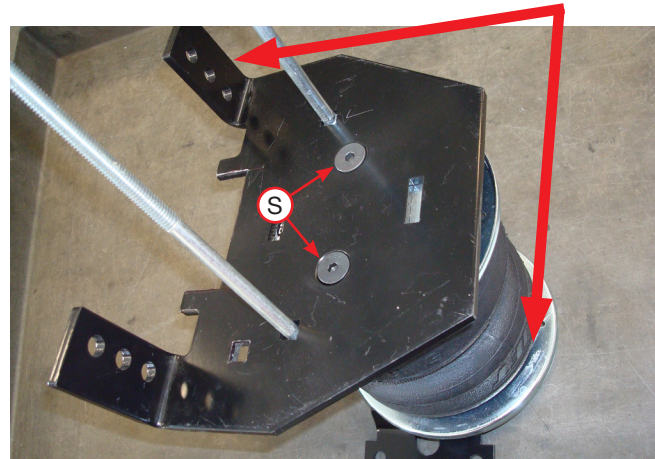

Fig. 12

- Insert the 3/8"-16 x 1" carriage bolt (I) (Fig. 13) through the top of the lower bracket. Flip over the assembly and install the lower bracket cup (C) onto the lower bracket main plate over carriage bolt and cap with serrated flange lock nut (Q) (Fig. 14). Snug bolt down but leave loose enough for the bracket to move freely in slot.

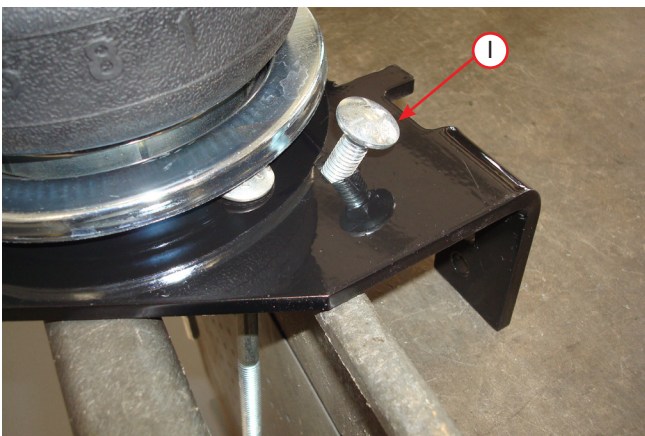

Fig. 13

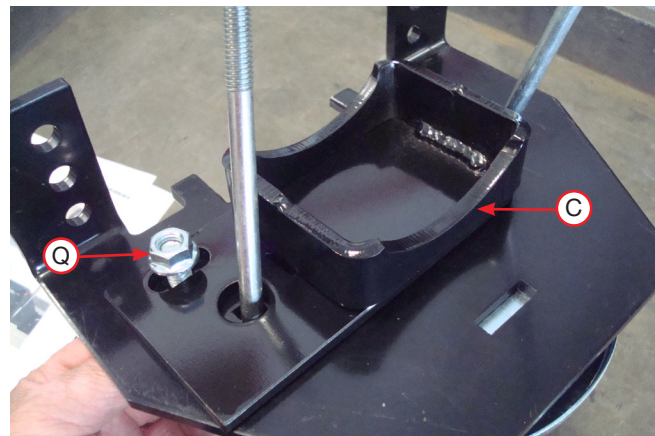
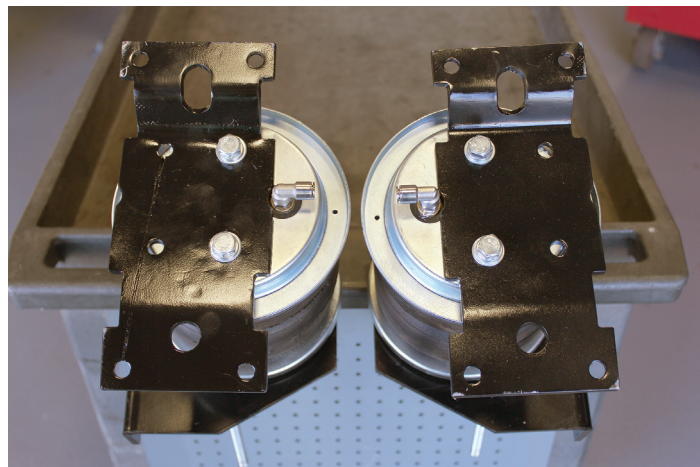

Fig. 14

- Fig. 15 shows the driver's (left) side and passenger's (right) side assemblies.

Driver's (left)
side assembly



Passenger's (right)
side assembly

Fig. 15

INSTALL THE AIR SPRING ASSEMBLIES

1. With the vehicle supported by safety stands, drop the axle or raise the body so that the assemblies can be put into position in between the axle and frame. Set the driver's (left) side and passenger's (right) side assemblies into position so that the lower bracket cup rests on the jounce bumper strike plate for single rear wheel (SRW) or the axle for dual rear wheel (DRW) applications.

NOTE

If there is a sway bar, insert the carriage bolts through the Clamp Bar (A) while setting the assemblies into position over the axle (see Fig. 19).

2. Push the lower bracket so that it is flush against the leaf spring stack. The flanges on the lower bracket main plate should lock on the sides of the U-bolt (Fig. 16).

NOTE

On the driver's (left) side, the long carriage bolt in the lower bracket main plate should be located between the hard brake line and axle (Fig. 22). On the passenger's (right) side, the carriage bolt should be located on the backside of the brake line (Fig. 23).

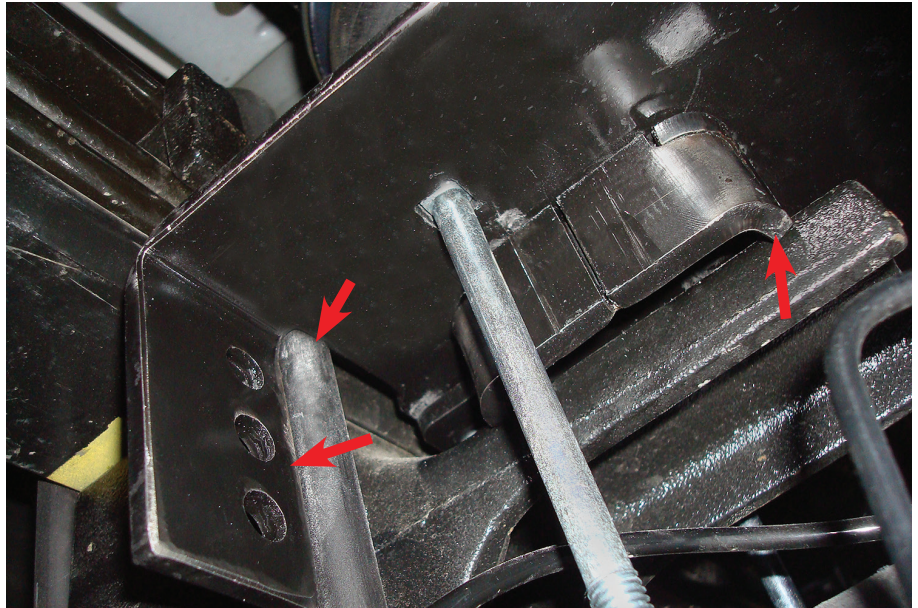

Fig. 16

3. Install the U-bolts (H) around the stock U-bolt/leaf spring assembly and insert through the topmost holes in the lower bracket main plates (Fig. 17). Cap with the 3/8" flat washer (V) and 3/8" nylon lock nuts (W). Snug bolts evenly, just enough to hold the lower bracket main plate flush against the stock U-bolts.

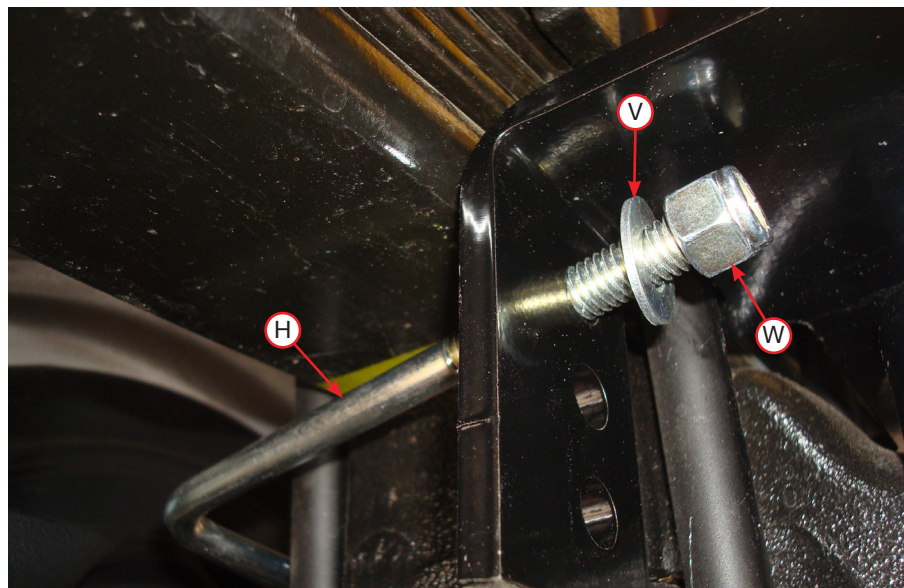
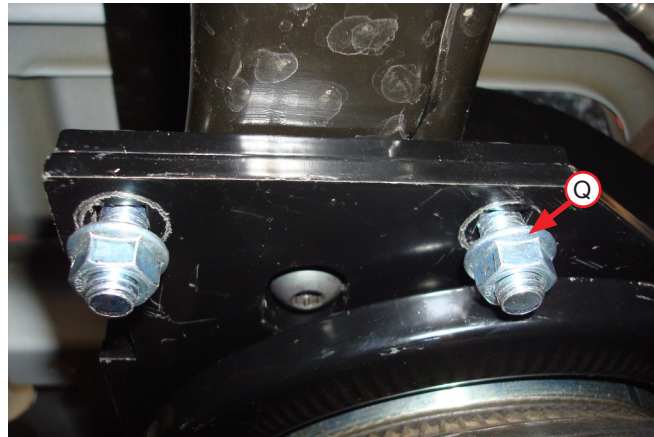

Fig. 17

- Before proceeding, ensure the 90-degree fittings each point inboard toward the center of the vehicle. While raising the axle or lowering the body of the vehicle, align the previously installed upper frame bracket carriage bolts with the air spring bracket holes so the carriage bolts protrude through the air spring bracket. Cap the carriage bolts with the 3/8" serrated flange lock nuts (Q) (Fig. 18). Snug the bolts down first, then torque to 31 lb.-ft. (42Nm). Finish raising the axle or lowering the body and remove safety stands.

Fig. 18

- If not completed, set the lower clamp bars (A) over the carriage bolts located under the axle (Fig. 19). Attach with the 3/8" flat washers (V) and 3/8" nylon lock nuts (W). Evenly torque the lower clamp bar hardware to 16 lb.-ft. (22Nm). Finish tightening the U-bolt hardware previously snugged by torquing to 10 lb.-ft. (14Nm).

TECH TIP

For sway bar applications, it's acceptable to tighten the front carriage bolt hardware down more than the rear to gain more clearance on the sway bar. Also, it may be necessary to use a 9/16" crows foot adapter to properly torque the hardware.

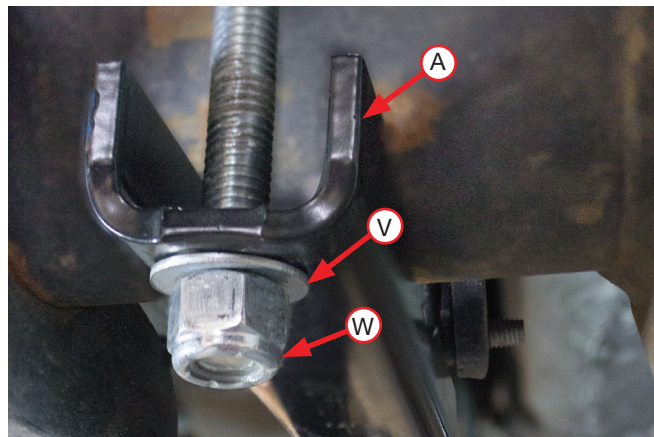
Fig. 19

- On vehicles that have a sway bar, cut the front carriage bolt just below the nut so it does not contact the sway bar (Fig. 20).

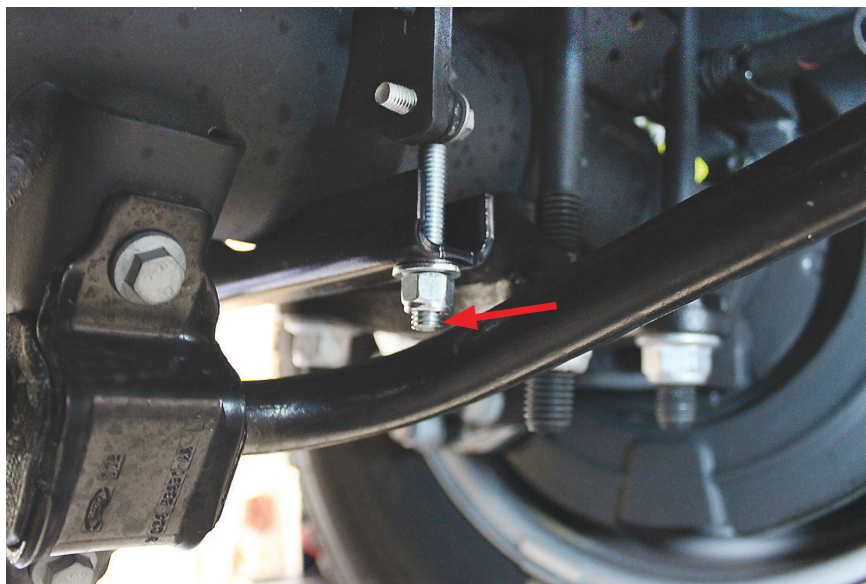
Fig. 20

7. Torque the nut (Q) to 32 lb.-ft. (43Nm) on both sides (Fig. 21).



Fig. 21

8. Once the lower brackets are secured, ensure the brake and ABS lines are not rubbing against the lower bracket carriage bolt. If necessary, pull or push the hard brake line away and tie off the ABS line to gain clearance.



On the passenger side, it may be necessary to pull the ABS tree mount out of the top of the bracket. Re-attach by installing the tree mount to the back (Figs. 22 & 23).



PUSH THE HARD BRAKE LINE AWAY FROM THE LOWER BRACKET CARRIAGE BOLT IF THE LINE IS RESTING ON IT (FIG. 22 & FIG. 23).

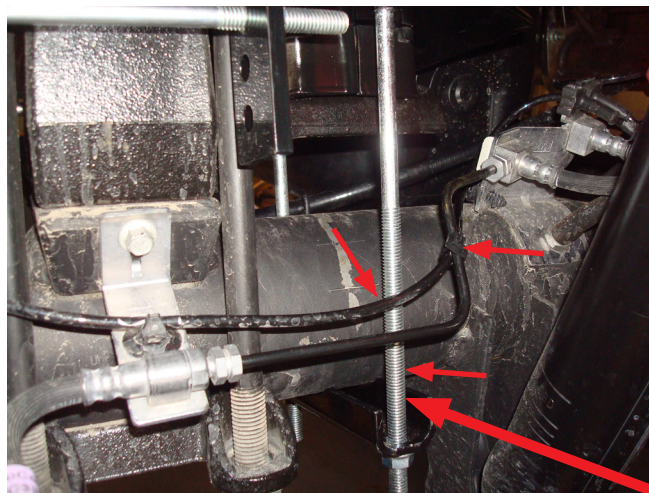

Fig. 22

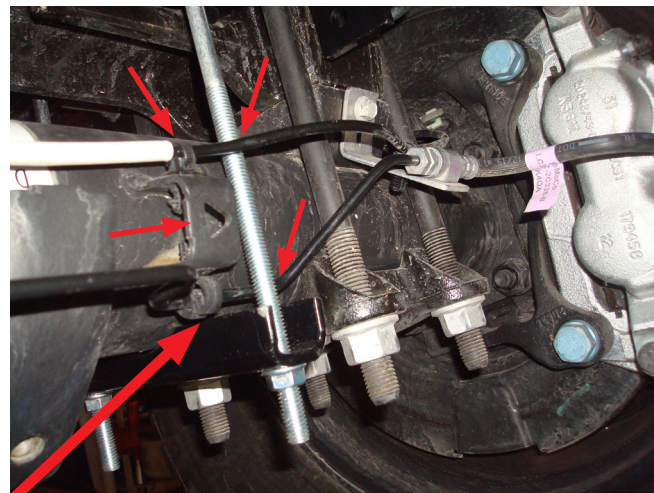
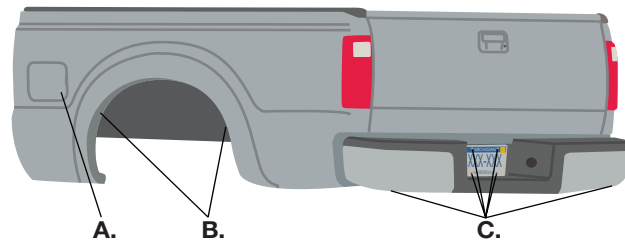

Fig. 23

Brake or ABS lines must not rub against the carriage bolt. Push or pull hard line out of the way. Move or zip tie ABS line out of the way.

Install the Air Lines

1. Choose the locations for the Schrader valves and drill a 5/16" (8mm) hole, if necessary.



A. Inside fuel tank filler door
 B. Inside rear wheel wells
 C. License plate or rear bumper area



KEEP AT LEAST 6" (152MM) OF CLEARANCE BETWEEN ALL AIR LINES AND THE EXHAUST SYSTEM. AVOID SHARP BENDS AND EDGES.

2. Make clean, square cuts with a razor blade or hose cutter when cutting the air line (AA). Do not use scissors or wire cutters.

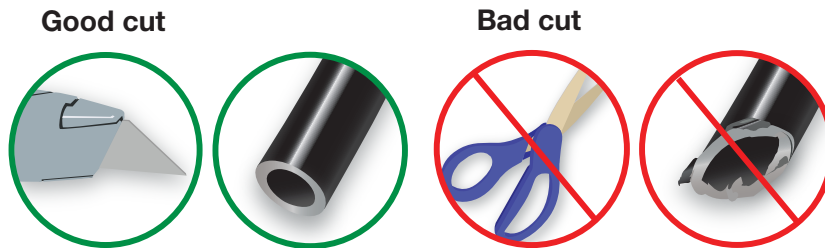

3. Use zip ties (BB) to secure the air line to fixed points along the chassis. Do not pinch or kink the air line. Leave at least 2" (51mm) of slack in the air line to allow for any movement that might pull on the air line. The minimum bend radius for the air line is 1" (25mm).

4. Install the Schrader valve in the chosen location.

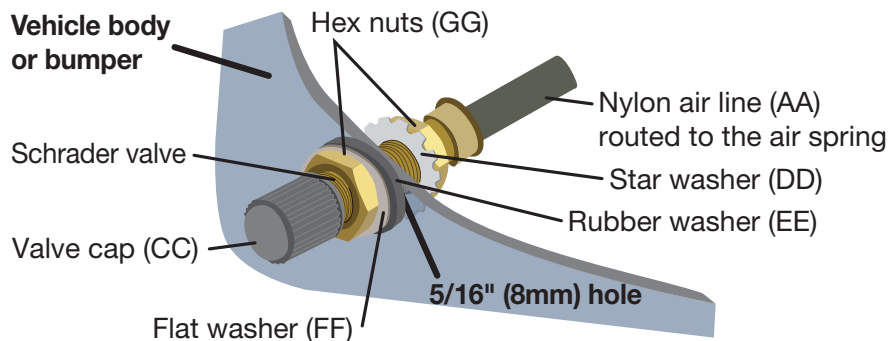

INSTALL THE HEAT SHIELD

Heat shield kit (HH) contents - (1) Heat shield, (1) Air line thermal sleeve and (4) Hose clamps:

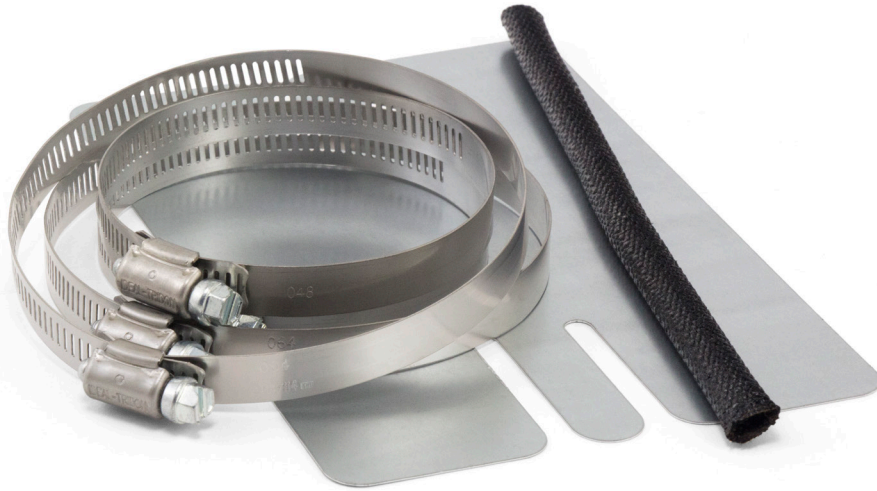

1. Attach the metal heat shield to the exhaust using the hose clamps where it is closest to the air spring. Slide the air line thermal sleeve over the air line and place it where the air line is closest to the exhaust.

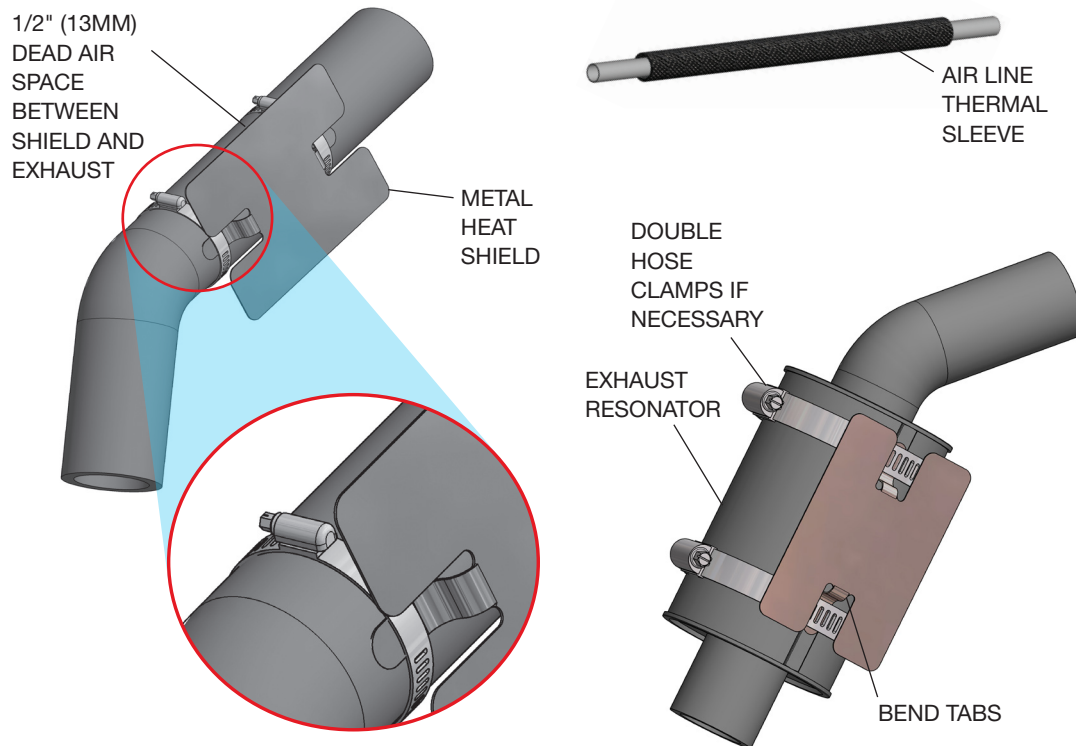

Finished Installation

These images show the finished installation of both sides for the F-250 and F-350 single rear wheel (SRW) applications.

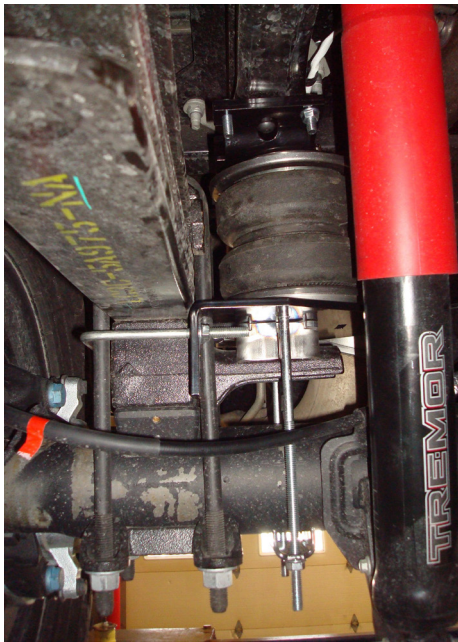

Passenger's (right) side front view



Passenger's (right) side inside frame view



Driver's (left) side rear view

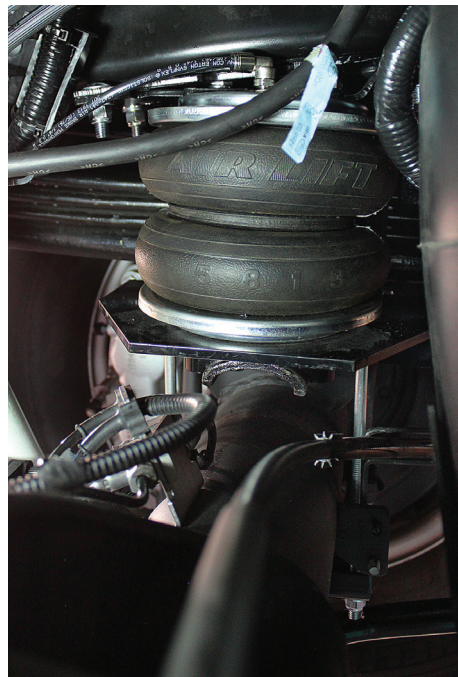

Driver's (left) side inside frame view

Congratulations!

You are now the proud owner of an Air Lift air suspension system. Enjoy!

Before Operating

INSTALLATION CHECKLIST

- ❑ **Clearance test** — Inflate the air springs to 40-60 PSI (2.8-4.1BAR) and make sure there is at least 1/2" (13mm) clearance from anything that might rub against each sleeve. Be sure to check the tire, brakes, frame, shock absorbers and brake cables.
- ❑ **Leak test before road test** — Inflate the air springs to 40-60 PSI (2.8-4.1BAR) and check all connections for leaks. All leaks must be eliminated before the vehicle is road-tested.
- ❑ **Heat test** — Be sure there is sufficient clearance from heat sources, at least 6" (152mm) for air springs and air lines. If a heat shield was included in the kit, install it. If there is no heat shield, but one is required, call Air Lift customer service at (800) 248-0892.
- ❑ **Fastener test** — After 500 miles (800km), recheck all bolts for proper torque.
- ❑ **Road test** — The vehicle should be road-tested after the initial tests. Inflate the air springs to recommended driving pressures. Drive the vehicle 10 miles (16km) and recheck for clearance, loose fasteners and air leaks.
- ❑ **Operating instructions** — If professionally installed, the installer should review the operating instructions with the owner. Be sure to provide the owner with all of the paperwork that came with the kit.

MAINTENANCE AND USE GUIDELINES

1. Check air pressure weekly.
2. Always maintain normal ride height. Never inflate beyond 100 PSI (7BAR).
3. If the system develops an air leak, use a soapy water solution to check all air line connections and the inflation valve core before deflating and removing the air spring.
4. Upon successful completion of the installation, follow these pressure requirements for the air springs.



**Minimum Recommended
Air Pressure**



Maximum Air Pressure



FOR SAFETY AND TO PREVENT POSSIBLE DAMAGE TO THE VEHICLE, DO NOT EXCEED MAXIMUM GROSS VEHICLE WEIGHT RATING (GVWR) OR PAYLOAD RATING, AS INDICATED BY THE VEHICLE MANUFACTURER.

ALTHOUGH THE AIR SPRINGS ARE RATED AT A MAXIMUM INFLATION PRESSURE OF 100 PSI (7BAR), THE AIR PRESSURE ACTUALLY NEEDED IS DEPENDENT ON LOAD AND GROSS VEHICLE WEIGHT RATING.



Limited Warranty and Return Policy

Air Lift Company provides a Limited Lifetime Warranty* to the original purchaser of its load support products, from the date of original purchase, that the products will be free from defects in workmanship and materials when used on cars and trucks as specified by Air Lift Company and under normal operating conditions, subject to the requirements and exclusions set forth in the full Limited Warranty and Return Policy.

*Full Limited Warranty and Return Policy are available at www.airliftcompany.com/warranty and are subject to change.

WARRANTY REGISTRATION & CLAIMS

- To register your warranty, please visit <https://www.airliftcompany.com/support/warranty/register/>
- To submit a warranty claim, please visit <https://www.airliftcompany.com/support/warranty/submit-claim/>



Thank you for purchasing Air Lift Products!

Need Help?

Contact Air Lift Company Customer Service at (800) 248-0892
or email service@airliftcompany.com.

For calls outside the U.S. or Canada, dial +1 (517) 322-2144.



Air Lift Company • 2727 Snow Road • Lansing, MI 48917 or P.O. Box 80167 • Lansing, MI 48908-0167

Air Lift Company reserves the right to make changes and improvements to its products and publications at any time.
For the latest version of this manual, contact Air Lift Company at (800) 248-0892 or visit airliftcompany.com.