



BX1747

2021-2024 GMC Yukon / Yukon XL AT4
(Only Vehicles Equipped w/ 4L) (Includes ACC & Shutters)
2021-2024 Chevy Suburban Z71 / Tahoe Z71 (Includes ACC & Shutters)
2019-2021 Chevy Silverado 1500 New Style (All Models)
2022 Chevy Silverado 1500 Limited (All Models)
Installation Instructions

Please read **BOTH** these Installation Instructions and the General Information sheet prior to installing or operating this equipment.



GMC Yukon / Yukon XL AT4



Chevy Suburban/Tahoe Z71



Chevy Silverado 1500

If the front of your vehicle looks different than this, please contact us at (402)385-3051.

Serial Number

Attachment Tab Height: 19.5"

Attachment Tab Width: 30"

Please ensure tow bar being used is compatible with the baseplate tab width.

1. Blue Ox® towing products and accessories are intended to be installed by Blue Ox® Dealers who are familiar with our products and have the equipment and knowledge necessary to do "fit work". If needed, Blue Ox® Dealers can be found at www.blueox.com or by contacting our Technical Service Department at (402) 385-3051.
2. Many Blue Ox® baseplates are designed to use existing holes and hardware to mount the baseplate to the towed vehicle. Even though bolts are there, do not assume they are adequate for baseplate mounting. Always use the hardware supplied in the hardware kit and existing hardware as specified in the installation instructions.



WARNING

Failure to read and follow these instructions could result in separation of the towed vehicle from the tow bar, causing property damage, loss of towed vehicle, personal injury or death.

Reference your vehicle owner's manual for manufacturer's towing specifications.

BX1747

2021-2024 GMC Yukon/Yukon XL AT4 (Only Vehicles Equipped w/4L) (Includes Adaptive Cruise Control & Shutters)
2021-2024 Chevy Suburban Z71/Tahoe Z71 (Includes Adaptive Cruise Control & Shutters)
2019-2021 Chevy Silverado 1500 New Style (All Models)
2022 Chevy Silverado 1500 Limited (All Models)
Installation Instructions

Bolt Torque Specifications

Torque in Foot-Pounds for Inch Bolts

Bolt Size	Grade 5	Grade 8
1/4"	10	14
5/16"	19	29
3/8"	33	47
7/16"	54	78
1/2"	78	119
5/8"	154	230
3/4"	257	380

Bolt Torque Specifications

Torque in Foot-Pounds for Metric Bolts

Bolt Size	Grade 8.8	Grade 10.9
6MM	6	8
8MM	16	22
10MM	31	40
12MM	54	70
14MM	89	117
16MM	161	230
18MM	222	318

Instruction Notes: The fascia and windshield washer fluid reservoir are removed and reinstalled for the baseplate installation. Some drilling and trimming is required.

Place all components that are removed on a flat, sturdy surface. All items will be reinstalled unless otherwise noted after the baseplate is installed.

The dimensional variations between otherwise identical vehicles can be considerable. While the baseplate was designed for easy installation, it may be necessary to tailor the baseplate slightly to compensate for vehicle manufacturer's tolerances.

The BX8869 Tail Light Wiring Kit is recommended for vehicles without LED lights and the BX8848 Tail Light Wiring Kit is recommended for vehicles with LED.



Drill a hole according to the tail light wiring kit instructions.

BX1747

2021-2024 GMC Yukon/Yukon XL AT4 (Only Vehicles Equiped w/4L) (Includes Adaptive Cruise Control & Shutters)

2021-2024 Chevy Suburban Z71/Tahoe Z71 (Includes Adaptive Cruise Control & Shutters)

2019-2021 Chevy Silverado 1500 New Style (All Models)

2022 Chevy Silverado 1500 Limited (All Models)

Installation Instructions

NOTICE

- Handling of some cosmetic parts when installing this product may require the use of protective covers, rags, specialty tools, etc. to prevent damage.
- When using power drills be aware of the dangers of torque and drill bit length.
- When using a reciprocating saw be aware of objects behind the cutting surface.
- Use a good quality paint to spray cut edges of frame to prevent rusting.
- Be sure that **ALL** electrical connections are plugged in and accessories are functioning properly before reinstalling the fascia.
- The baseplate is computer tested to your vehicle's GVWR, exceeding this weight will void the manufacturer's warranty.
- Be sure to use a sufficient amount of Loctite® Red on all bolt threads before tightening. Tighten all bolts according to the torque chart provided unless specified.
- Dealer or installer be certain the user receives these instruction sheets.
- If the baseplate is in an accident, it must be replaced. **DO NOT** use it again! An accident can cause unseen damage and using it again could result in more damage or serious injury. **DO NOT** use the baseplate if it is damaged or missing parts.

BX1747

2021-2024 GMC Yukon/Yukon XL AT4 (Only Vehicles Equipped w/4L) (Includes Adaptive Cruise Control & Shutters)
 2021-2024 Chevy Suburban Z71/Tahoe Z71 (Includes Adaptive Cruise Control & Shutters)
 2019-2021 Chevy Silverado 1500 New Style (All Models)
 2022 Chevy Silverado 1500 Limited (All Models)

Installation Instructions

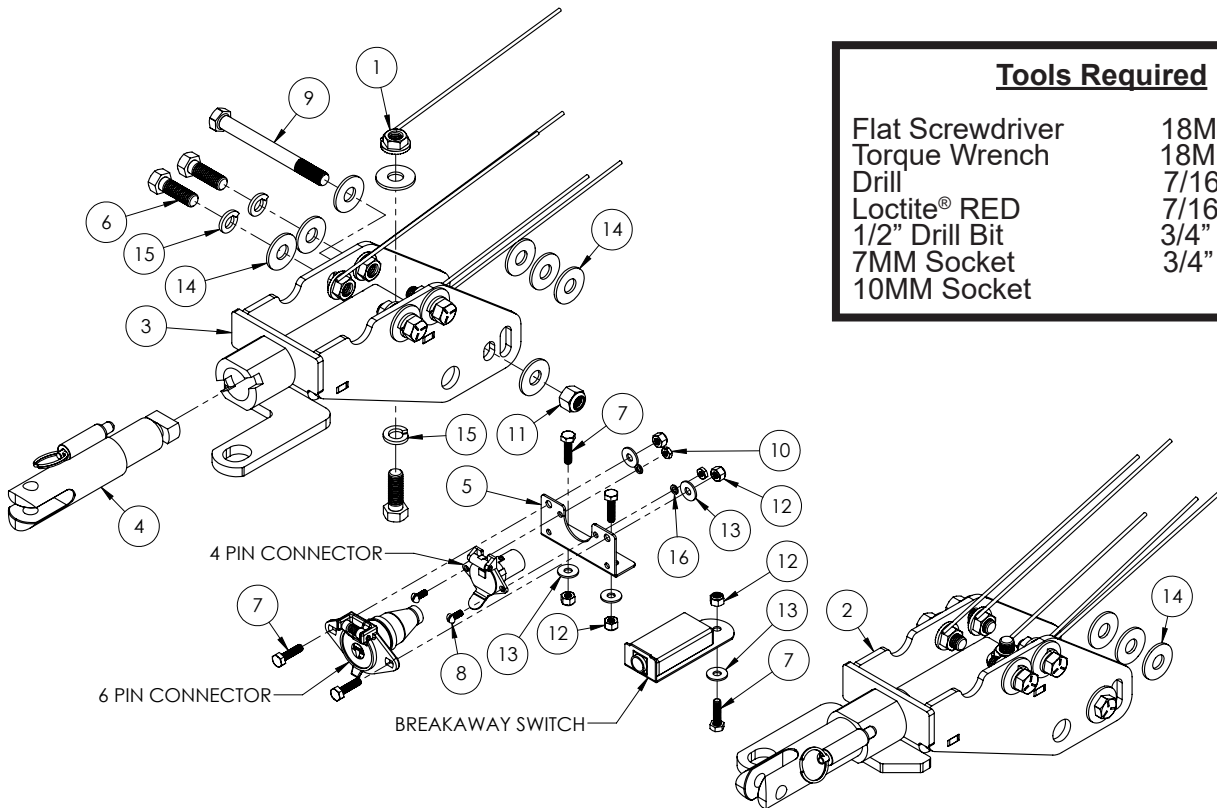

Tools Required	
Flat Screwdriver	18MM Socket
Torque Wrench	18MM Wrench
Drill	7/16" Socket
Loctite® RED	7/16" Wrench
1/2" Drill Bit	3/4" Socket
7MM Socket	3/4" Wrench
10MM Socket	

Item No.	Part No.	Description	Qty.
1.....	61-4029.....	1/2"-13 Whiz Nut with 10" Wire	10
2.....	61-8470.....	BX1747 Baseplate, DS.....	1
3.....	61-8471.....	BX1748 Baseplate, PS.....	1
4.....	62-3468.....	Attachment Tab Assembly with Hole	2
5.....	101-6135.....	Electrical Bracket, 90° Bend.....	1
6.....	201-0051.....	1/2"-13 x 1-1/2" Hex Head Bolt, Grade 5, ZP	10
7.....	201-0071.....	1/4"-20 x 1" Hex Head Bolt, Grade 5, ZP	5
8.....	201-0192.....	#10-32 1/2" Round Slotted Head Screw.....	2
9.....	201-0786.....	1/2"-13 x 5" Hex Head Bolt, Grade 5, ZO	2
10.....	202-0047.....	#10-32 Hex Nut	2
11.....	202-0094.....	1/2"-13 Hex Nylon Insert Lock Nut, ZP.....	2
12.....	202-0102.....	1/4"-20 Hex Nylon Nut, ZP	5
13.....	203-0001.....	1/4" Flat Washer, ZP.....	5
14.....	203-0005.....	1/2" Flat Washer	20
15.....	203-0012.....	1/2" Lock Washer, ZP	10
16.....	203-0054.....	#10 Lock Washer, ZP	2
17.....	226-0049(not shown).....	Class IV Safety Cables.....	2
18.....	229-0512(not shown).....	1/2" Quicklink, ZP	2
19.....	290-0437(not shown).....	Black Cap Plug Receiver.....	2

Important:

Use only genuine factory replacement parts on your baseplate. Do **NOT** substitute homemade or non-typical parts. If a bolt is lost or in need of replacement, for your safety and the preservation of your baseplate, be sure to use a replacement bolt of the same grade (In most cases it will be Grade 5, please reference the parts list above). Replacement parts may be ordered through your nearest Blue Ox® Dealer or Distributor. Failing to follow and/or altering these installation instructions in either installation or required equipment will void the manufacturer's warranty. Towing behind a non-motorized vehicle will void the warranty.

BX1747

2021-2024 GMC Yukon/Yukon XL AT4 (Only Vehicles Equipped w/4L) (Includes Adaptive Cruise Control & Shutters)
2021-2024 Chevy Suburban Z71/Tahoe Z71 (Includes Adaptive Cruise Control & Shutters)
2019-2021 Chevy Silverado 1500 New Style (All Models)
2022 Chevy Silverado 1500 Limited (All Models)
Installation Instructions

Chevy Silverado 1500 Fascia Removal:



1. Using a T15 Torx, remove the two (2) bolts from the handle on the top edge of the fascia. Remove and set aside to be reinstalled later.

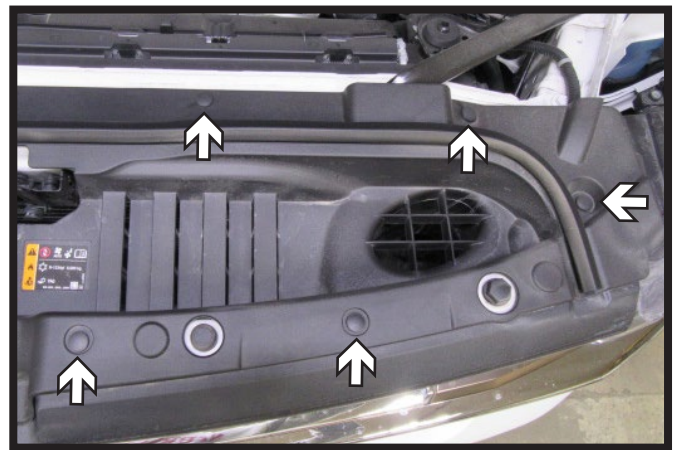
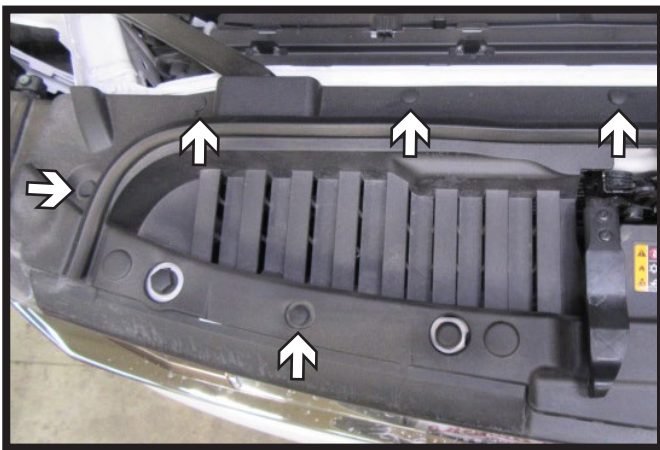

2. Remove the ten (10) push pins from along the top of the fascia. Remove fascia cover and set aside to be reinstalled later.

BX1747

2021-2024 GMC Yukon/Yukon XL AT4 (Only Vehicles Equipped w/4L) (Includes Adaptive Cruise Control & Shutters)
2021-2024 Chevy Suburban Z71/Tahoe Z71 (Includes Adaptive Cruise Control & Shutters)
2019-2021 Chevy Silverado 1500 New Style (All Models)
2022 Chevy Silverado 1500 Limited (All Models)
Installation Instructions



3. Using a 7MM socket, remove the four (4) bolts, two (2) on each side from the top of the fascia.

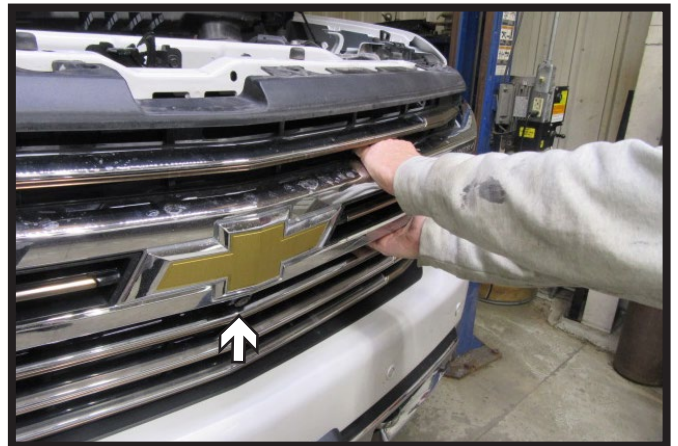

4. Use a flat head screw drive to release fascia where the bolts were removed, grip grill in center and pull outward to unsnap at top and bottom. Unplug camera in the center of grill (white). Remove grill and set aside to be reinstalled later.

BX1747

2021-2024 GMC Yukon/Yukon XL AT4 (Only Vehicles Equipped w/4L) (Includes Adaptive Cruise Control & Shutters)

2021-2024 Chevy Suburban Z71/Tahoe Z71 (Includes Adaptive Cruise Control & Shutters)

2019-2021 Chevy Silverado 1500 New Style (All Models)

2022 Chevy Silverado 1500 Limited (All Models)

Installation Instructions

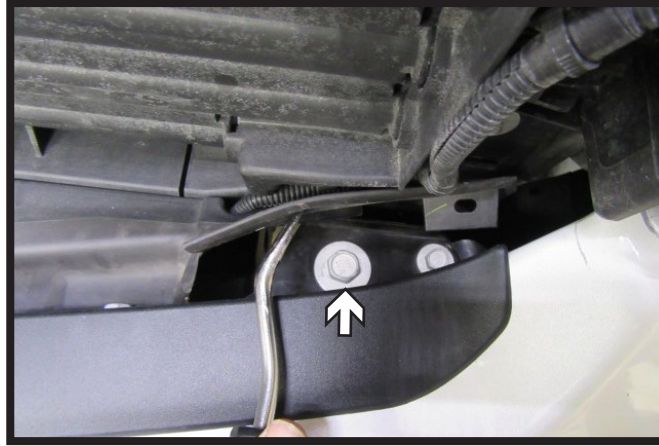

5. Pull back plastic piece at the corner of the bumper. Using an 18MM socket, remove the one (1) bolt. Do this on both sides of the vehicle.

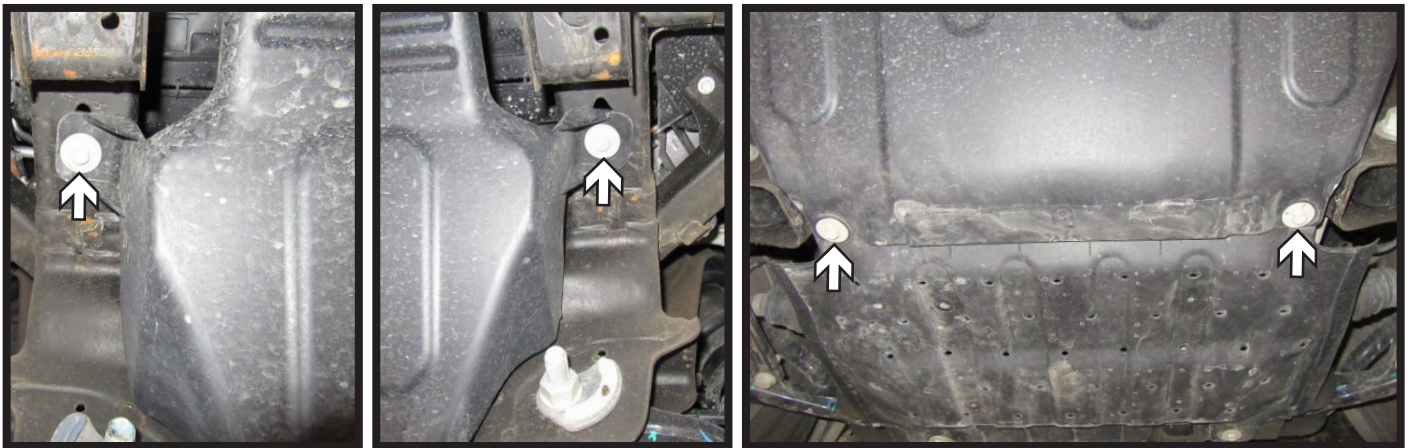

6. Using a 13MM socket, remove the four (4) bolts from the belly pan. There are two (2) in the front and two (2) in the back. Remove belly pan and set aside to be reinstalled later.

BX1747

2021-2024 GMC Yukon/Yukon XL AT4 (Only Vehicles Equipped w/4L) (Includes Adaptive Cruise Control & Shutters)
2021-2024 Chevy Suburban Z71/Tahoe Z71 (Includes Adaptive Cruise Control & Shutters)
2019-2021 Chevy Silverado 1500 New Style (All Models)
2022 Chevy Silverado 1500 Limited (All Models)
Installation Instructions

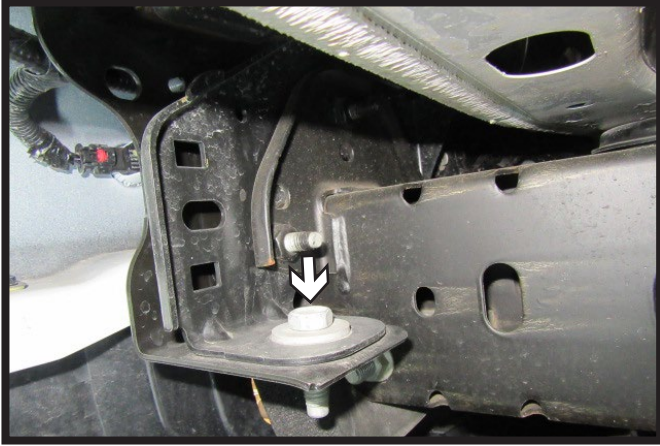

7. Using an 18MM socket, remove the one (1) bolt beside the tow hook housing. Do this on both sides of the vehicle.

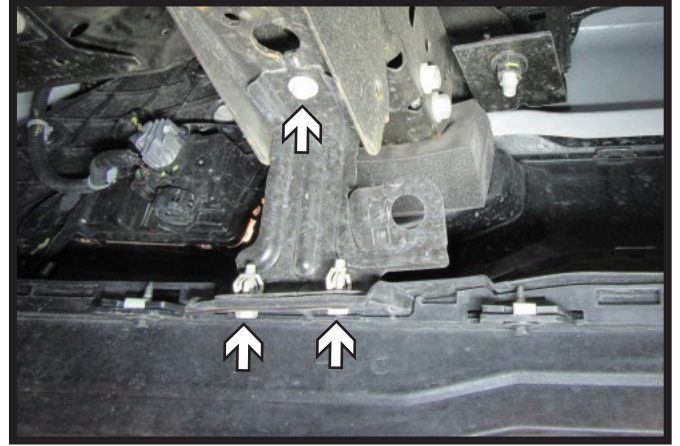

8. Using a 10MM socket, remove the three (3) bolts from the underside of the vehicle. Do this on both sides of the vehicle.



9. Using a 15MM socket, remove the one (1) bolt as shown. Do this on both sides of the vehicle. Unplug the main wiring harness on the passenger side of the vehicle (inset). Remove bumper and set aside to be reinstalled later.

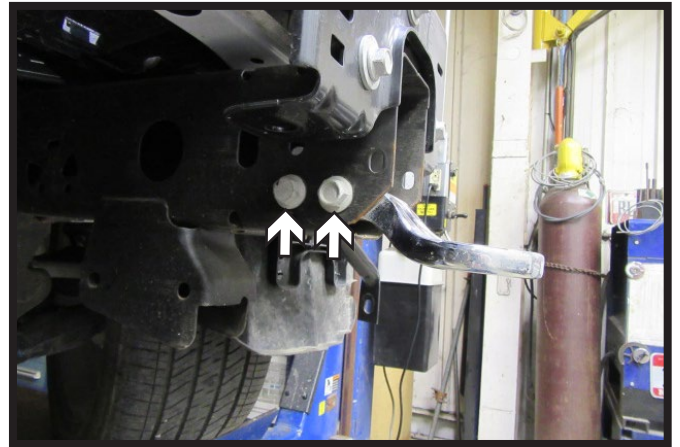

10. Using an 18MM socket, remove the two (2) bolts from the tow hook. Remove tow hook and set aside, it will not be reinstalled. Do this on both sides of the vehicle.

continue to page 13

BX1747

2021-2024 GMC Yukon/Yukon XL AT4 (Only Vehicles Equipped w/4L) (Includes Adaptive Cruise Control & Shutters)
2021-2024 Chevy Suburban Z71/Tahoe Z71 (Includes Adaptive Cruise Control & Shutters)
2019-2021 Chevy Silverado 1500 New Style (All Models)
2022 Chevy Silverado 1500 Limited (All Models)
Installation Instructions

GMC Yukon / Yukon XL AT4 & Chevy Suburban / Tahoe Z71 Fascia Removal:

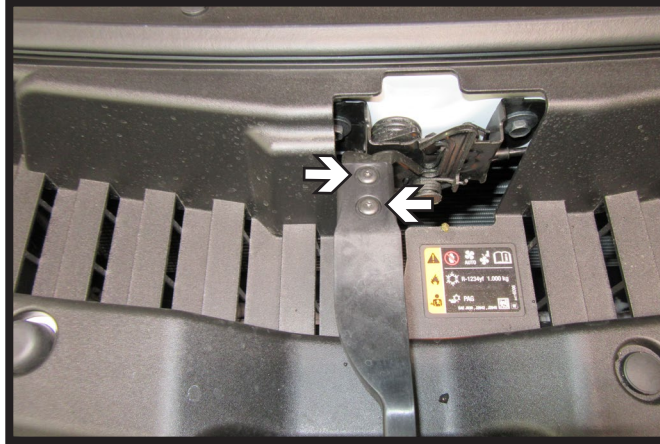

1. Using a T15 Torx, remove the two (2) bolts from the hood release handle.

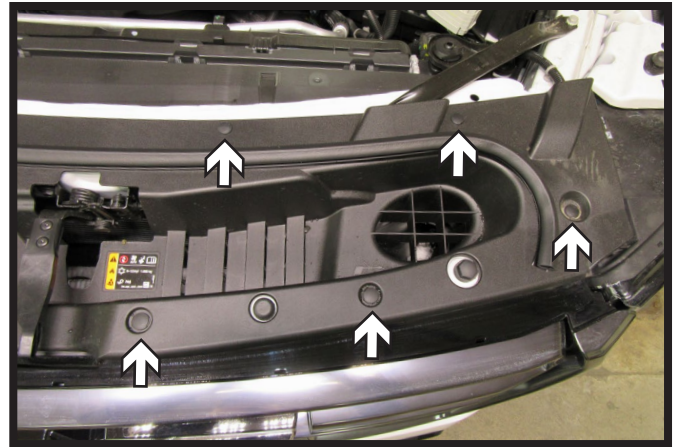
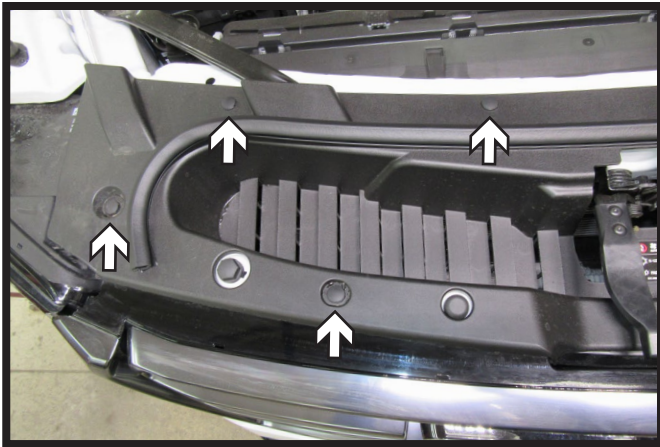

2. Remove the nine (9) push pins from the fascia cover. Remove cover and set aside to be reinstalled later.

BX1747

2021-2024 GMC Yukon/Yukon XL AT4 (Only Vehicles Equipped w/4L) (Includes Adaptive Cruise Control & Shutters)
2021-2024 Chevy Suburban Z71/Tahoe Z71 (Includes Adaptive Cruise Control & Shutters)
2019-2021 Chevy Silverado 1500 New Style (All Models)
2022 Chevy Silverado 1500 Limited (All Models)
Installation Instructions

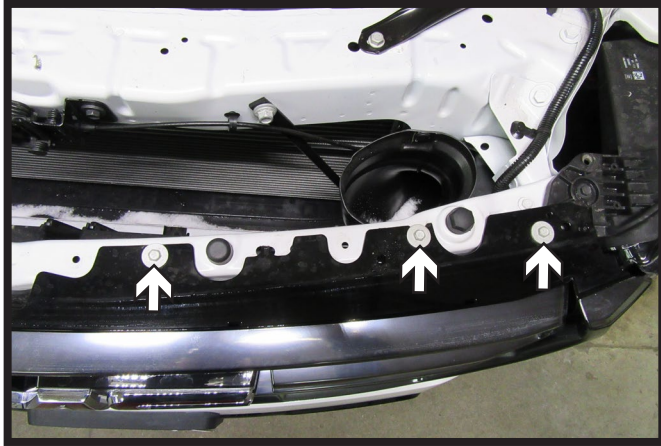

3. Using a 10MM socket, remove the six (6) bolts, three (3) on each side, from the top of the fascia.

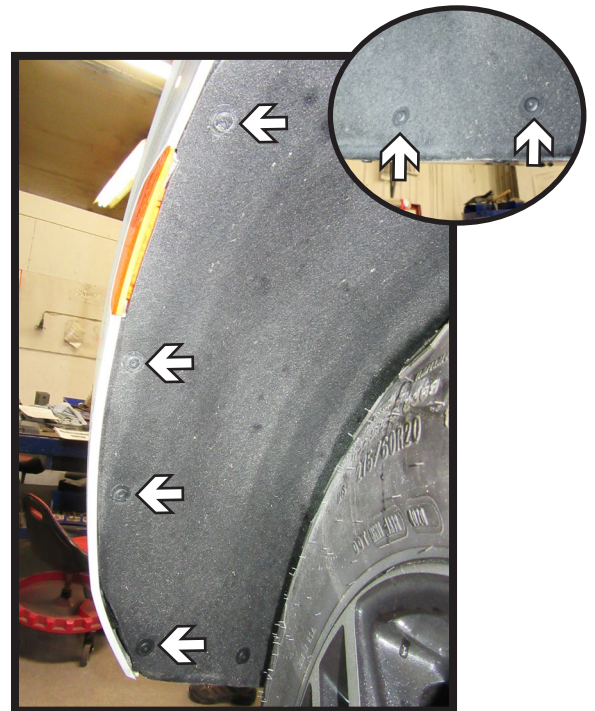

4a. **GMC Yukon / Yukon AT4 Models:** Using a T15 Torx, remove the six (6) bolts, four (4) along the wheel well edge and two (2) in front of the tire (inset). Do this on both sides of the vehicle.



4b. **Chevy Suburban / Tahoe Z71 Models:** Using a T15 Torx, remove the four (4) bolts, three (3) along the wheel well edge and one (1) in front of the tire. Do this on both sides of the vehicle.

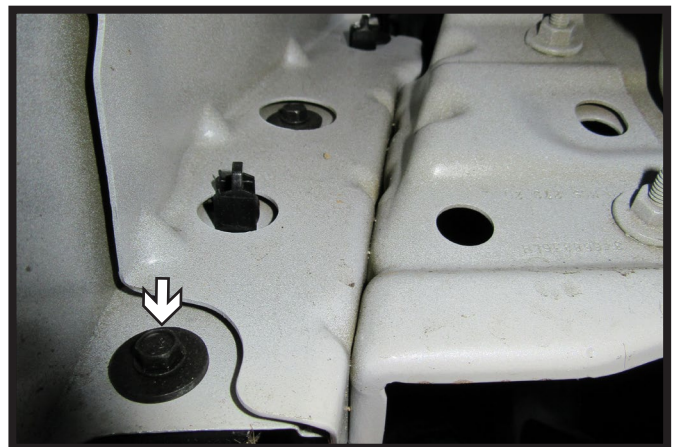

5. Pull back the wheel well liner. Using a 7MM socket, remove the one (1) bolt from the fascia joint. Do this on both sides of the vehicle.

BX1747

2021-2024 GMC Yukon/Yukon XL AT4 (Only Vehicles Equipped w/4L) (Includes Adaptive Cruise Control & Shutters)
2021-2024 Chevy Suburban Z71/Tahoe Z71 (Includes Adaptive Cruise Control & Shutters)
2019-2021 Chevy Silverado 1500 New Style (All Models)
2022 Chevy Silverado 1500 Limited (All Models)
Installation Instructions



6. Unplug the electrical connections behind the wheel well liner on the passenger side of the vehicle.

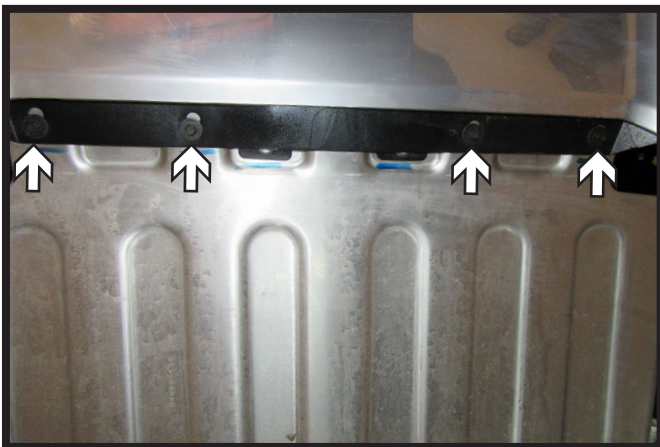

- 7a. **GMC Yukon / Yukon AT4 Models:** Using a 7MM socket, remove the four (4) bolts from the underside of the fascia.

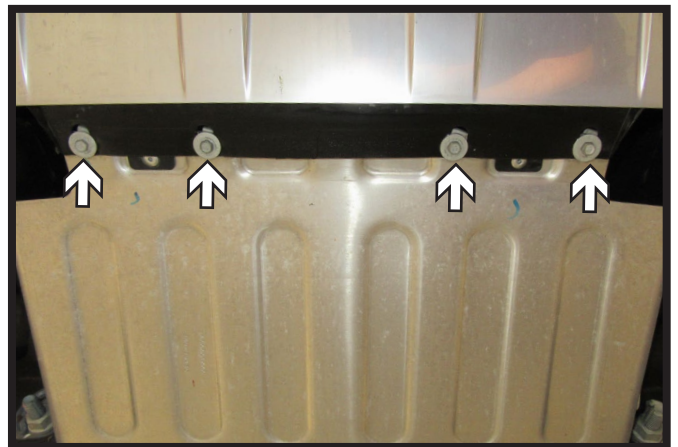

- 7b. **Chevy Suburban / Tahoe Z71 Models:** Using a 10MM socket, remove the four (4) bolts from the underside of the fascia.

BX1747

2021-2024 GMC Yukon/Yukon XL AT4 (Only Vehicles Equipped w/4L) (Includes Adaptive Cruise Control & Shutters)
2021-2024 Chevy Suburban Z71/Tahoe Z71 (Includes Adaptive Cruise Control & Shutters)
2019-2021 Chevy Silverado 1500 New Style (All Models)
2022 Chevy Silverado 1500 Limited (All Models)
Installation Instructions



8a. **GMC Yukon / Yukon AT4 Models:** Using a T15 Torx, remove the two (2) bolts on the underside of the fascia in front of the tire. Do this on both sides of the vehicle.



8b. **Chevy Suburban / Tahoe Z71 Models:** Using a T15 Torx, remove the one (1) bolts on the underside of the fascia in front of the tire. Do this on both sides of the vehicle.

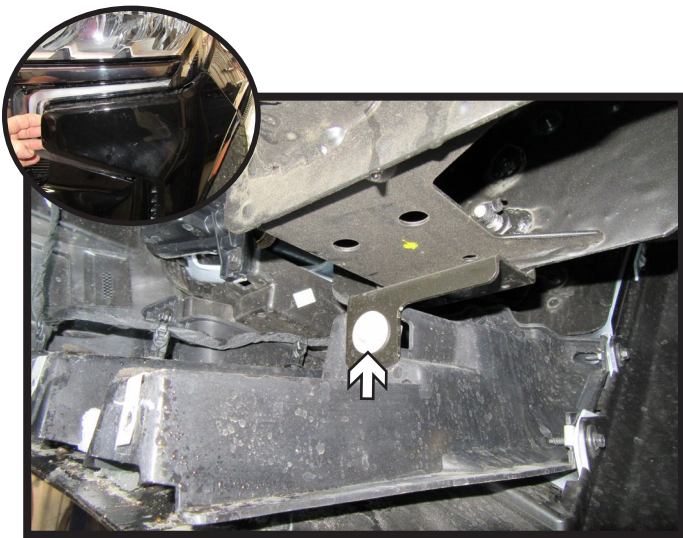

9. Pull down the liner on the underside of the fascia in front of the tire. Using a 10MM socket, remove the one (1) bolt. Do this on both sides of the vehicle. Remove fascia and set aside to be reinstalled later.

Note: Chevy Suburban / Tahoe Z71 Models, unsnap fascia around head light to allow for fascia removal (inset).

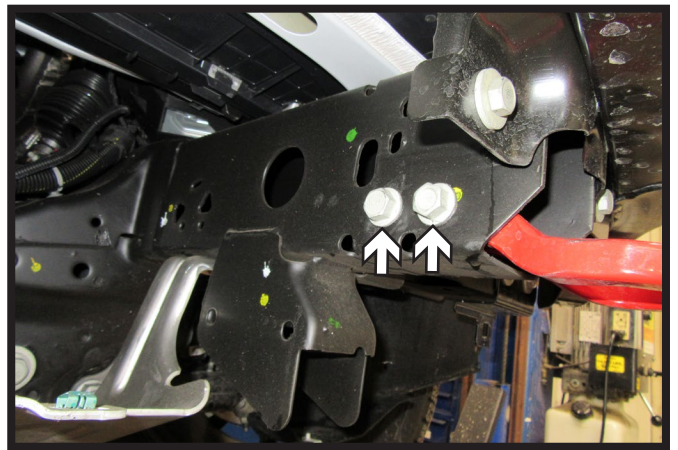

10. Using an 18MM socket, remove the two (2) bolts for the tow hook. Do this on both sides of the vehicle. Remove tow hooks and set aside, they will not be reinstalled later.

continue to page 13

BX1747

2021-2024 GMC Yukon/Yukon XL AT4 (Only Vehicles Equipped w/4L) (Includes Adaptive Cruise Control & Shutters)
2021-2024 Chevy Suburban Z71/Tahoe Z71 (Includes Adaptive Cruise Control & Shutters)
2019-2021 Chevy Silverado 1500 New Style (All Models)
2022 Chevy Silverado 1500 Limited (All Models)
Installation Instructions

Baseplate Installation:

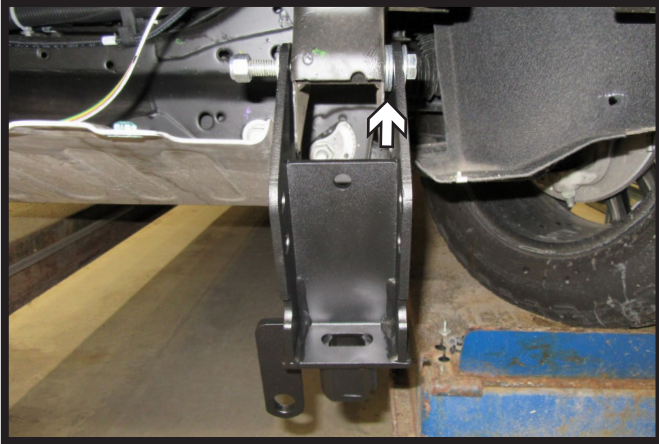

1. Slide baseplate onto tow hook housing so that the back slotted hole of the baseplate lines up with back hole on housing. Insert the one (1) 1/2" x 5" bolt with washers on the outside and two (2) spacers as shown. Leave loose at this time. Do this on both sides of the vehicle.

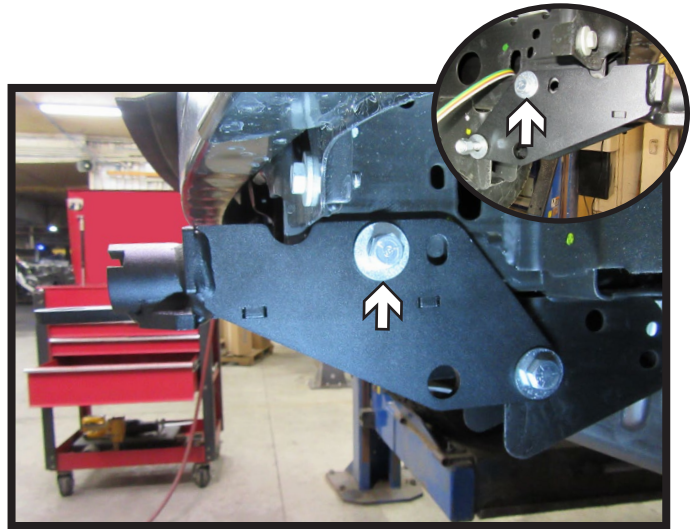

2. Rotate baseplate upward and install the outer front and inner back 1/2" bolts with hardware. Remove the back lower bolt, apply Loctite Red and reinstall. Do this on both sides of the vehicle.

Note: If top front holes do not line up, the back lower bolt may need to be switched to the other slotted hole.

**** Use Loctite® Red on all bolt threads and tighten all bolts to the appropriate torque. ****

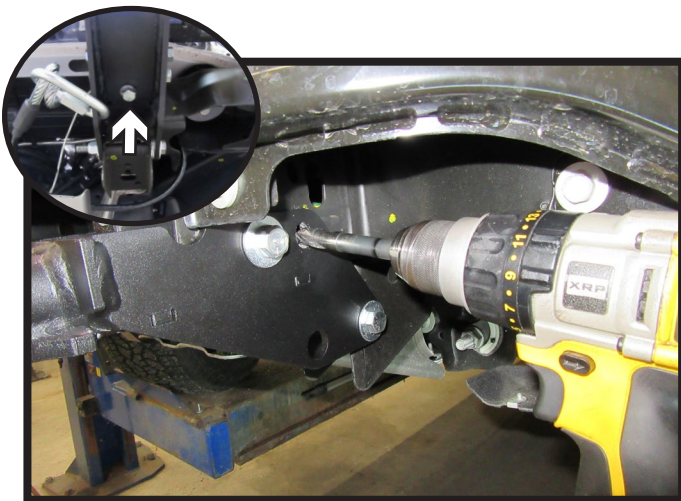

3. Using a 1/2" drill bit, drill the top rear hole on the side of the baseplate and the bottom hole (inset), using the baseplate as a template. Do this on both sides of the vehicle.

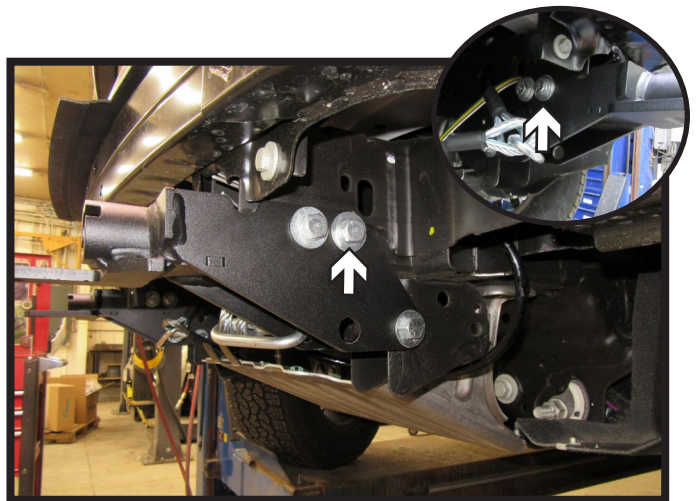

4. Install the inner front and outer back 1/2" bolts with hardware. Do this on both sides of the vehicle.

**** Use Loctite® Red on all bolt threads and tighten all bolts to the appropriate torque. ****

BX1747

2021-2024 GMC Yukon/Yukon XL AT4 (Only Vehicles Equipped w/4L) (Includes Adaptive Cruise Control & Shutters)
2021-2024 Chevy Suburban Z71/Tahoe Z71 (Includes Adaptive Cruise Control & Shutters)
2019-2021 Chevy Silverado 1500 New Style (All Models)
2022 Chevy Silverado 1500 Limited (All Models)

Installation Instructions

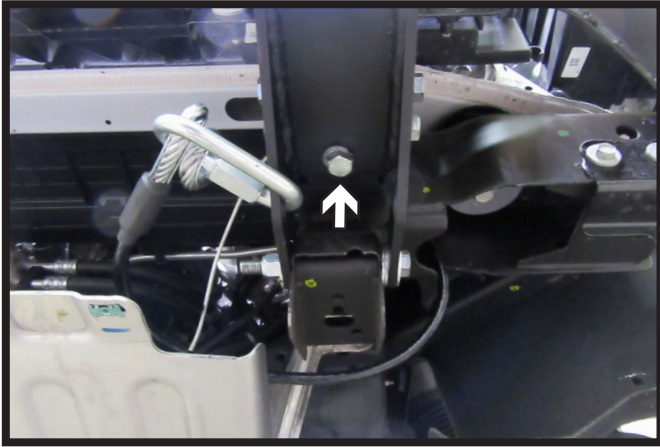

5. Install the 1/2" bolt with hardware into the bottom hole of the baseplate. Do this on both sides of the vehicle.

**** Use Loctite® Red on all bolt threads and tighten all bolts to the appropriate torque. ****



6. Attach the permanent baseplate safety cables to the provided convenience link on the baseplate. The photo above shows the recommended installation of the cables to frame of vehicle. Additional options may interfere with suggested mounting; in this case, secure the cables to a solid piece of the frame as described in the General Information sheet. Be sure the safety cables do not rub against any hoses or moving parts. Do this on **BOTH** sides of the vehicle.



7. Hold the fascia as close to its original position, mark and trim the fascia around the convenience links and attachment tabs. Reinstall the fascia, fascia cover and reconnect all electrical.

BX1747

2021-2024 GMC Yukon/Yukon XL AT4 (Only Vehicles Equiped w/4L) (Includes Adaptive Cruise Control & Shutters)

2021-2024 Chevy Suburban Z71/Tahoe Z71 (Includes Adaptive Cruise Control & Shutters)

2019-2021 Chevy Silverado 1500 New Style (All Models)

2022 Chevy Silverado 1500 Limited (All Models)

Installation Instructions

CUSTOMER SERVICE COMMITMENT

Blue Ox® is committed to providing you with exceptional customer care throughout your lifetime with our products. Our team is here to assist you with any questions you may have regarding the performance of your product. Simply call (402) 385-3051 and you can speak with our technical service team.

Additionally, please visit our website to see which rallies our Destination America team will be attending. For a nominal fee, our service technician will service your towing system to ensure it's in proper working condition. Also, as a commitment to our customers, should you visit our factory, you can stay at our full service Blue Ox® campground at no charge along with enjoying a factory tour.

Again, thank you for being our customer and for the confidence you have shown in the performance of our products. It is because of customers like you we enjoy the success we have today.



© 2022 Blue Ox
One Mill Road, Industrial Park
Pender, Nebraska 68047
Phone: (402) 385-3051
Fax: (402) 385-3360
www.blueox.com

General Information

1. Ensure that your product(s) are registered online at www.blueox.com. It is crucial to register your product(s) so that you may be alerted of product offerings, updates, upgrades, maintenance and safety bulletins, and/or recalls.
2. **It is the owner's responsibility to inspect all towing equipment for cracked welds, missing or worn parts and loose bolts before each towing trip.** Be sure to use Loctite® Red on all bolts and tighten to the recommended specifications.
3. **It is the owner's responsibility to hook up all towing equipment per manufacturer's instructions/recommendations.**
4. Remove the attachment tabs when not in use (if applicable).

Notice To Baseplate Installer

1. It is YOUR responsibility to watch for:

- Oil cooler and air conditioner lines
- Electrical wires and hoses
- Missing parts or attaching points on the frame

** If the baseplate is improperly installed and is against a wire or hose, it could cause fluid leaks or electrical shorts some time after the actual baseplate installation.

Permanent Baseplate Safety Cable Installation

Permanent baseplate safety cables are strongly recommended when towing a vehicle with a tow bar. The principle function of the permanent baseplate safety cables is to prevent the towed vehicle from breaking loose in the event the connection between the frame of the towed vehicle and the baseplate fails or becomes disconnected. The cables must be connected from the baseplate to the frame rail or cross member of the vehicle's frame. The illustrations below show the possible arrangements recommended by Blue Ox®. Each permanent baseplate safety cable must have an adequate weight rating for the towing system. The weight rating of the two (2) cables together will not qualify.

Do not mount the permanent baseplate safety cables against wires, hoses or brake lines.

These permanent baseplate safety cables should remain installed as long as the baseplate is installed on the vehicle. Permanent baseplate safety cables are to be used in conjunction with, and NOT a replacement for legally required safety cables attaching the towed vehicle to the towing vehicle.

Option #1

(Baseplates with Convenience Link Tabs)



Option #2

(Baseplates with out Convenience Link Tabs)



BLUE OX ORIGINAL PURCHASERS THREE YEAR LIMITED WARRANTY

Automatic Equipment Manufacturing Company ("Automatic") warrants to the original (first) retail purchaser that this product, manufactured by Automatic, shall be free from defect in material and workmanship under normal use and service for a period of three years from the date of delivery.

During said three-year period, Automatic will repair or replace any parts that have been returned by the original purchaser, to the factory, transportation prepaid, and in Automatic's sole and absolute opinion found to be defective.

Limitations on Warranty Coverage:

Coverage under this warranty will be valid only if the customer warranty card is returned by the original purchaser within 30 days of purchase.

Coverage under this warranty will be effective only when a copy of the original invoice, showing date and place of purchase, accompanies any claim for warranty. This warranty is NON TRANSFERABLE.

This limited warranty will not cover, in any way or form, any alleged damages caused by incorrect or improper installation, improper use, modification or neglect of product, failure to properly service and maintain, misuse, act of God, accident or failure of the user to follow guidelines contained in the instructional material provided by Automatic.

This warranty does not cover normal wear and tear, paint or rust.

Warrantor assumes no responsibility to the owner for loss of use of product, loss of time, inconvenience or any other damage consequential or otherwise. Including, but not limited to mileage, expense of transporting of product, return shipping expense, mechanics travel time, telephone, road service, towing, and rental during repairs, travel, lodging, loss or damage to personal property or loss of earnings.

REPAIR OR REPLACEMENT AS SET FORTH IN THIS LIMITED WARRANTY IS THE SOLE EXCLUSIVE REMEDY OF THE PURCHASER. AUTOMATIC SHALL NOT BE LIABLE FOR ANY INCIDENTAL OR CONSEQUENTIAL DAMAGES FOR BREACH OF ANY EXPRESS OR IMPLIED WARRANTY ON THIS PRODUCT. EXCEPT TO THE EXTENT PROHIBITED BY APPLICABLE LAW, ANY IMPLIED WARRANTY OF MERCHANTABILITY OR FITNESS FOR A PARTICULAR PURPOSE ON THIS PRODUCT IS LIMITED IN LENGTH TO THE DURATION OF THIS WARRANTY.

Please visit <http://blueox.com/warranty/> to register your warranty

