



BX2628

2011-14 Ford Edge

(Includes Adaptive Cruise Control)(No 2.0L EcoBoost AWD)

Installation Instructions

Attachment Tab Height: 26-1/2"

Attachment Tab Width: 26"

Serial Number

Please read BOTH these Installation Instructions and the General Information sheet prior to installing or operating this equipment.

- Blue Ox® towing products and accessories are intended to be installed by Blue Ox® Dealers who are familiar with our products and have the equipment and knowledge necessary to do "fit work". If needed, Blue Ox® Dealers can be found at www.blueox.com or by contacting our Technical Service Department at (402) 385-3051.
- Many Blue Ox® baseplates are designed to use existing holes and hardware to mount the baseplate to the towed vehicle. Even though bolts are there, do not assume they are adequate for baseplate mounting. Always use the hardware supplied in the hardware kit and existing hardware as specified in the installation instructions.



If the front of your vehicle looks different than this, please contact us at (402)385-3051.

Reference your vehicle owner's manual for manufacturer's towing specifications.

Bolt Torque Specifications

Torque in Foot-Pounds for Inch Bolts

| Bolt Size | Grade 5 | Grade 8 |
|-----------|---------|---------|
| 1/4" | 10 | 14 |
| 5/16" | 19 | 29 |
| 3/8" | 33 | 47 |
| 7/16" | 54 | 78 |
| 1/2" | 78 | 119 |
| 5/8" | 154 | 230 |
| 3/4" | 257 | 380 |

Bolt Torque Specifications

Torque in Foot-Pounds for Metric Bolts

| Bolt Size | Grade 8.8 | Grade 10.9 |
|-----------|-----------|------------|
| 6MM | 6 | 8 |
| 8MM | 16 | 22 |
| 10MM | 31 | 40 |
| 12MM | 54 | 70 |
| 14MM | 89 | 117 |
| 16MM | 161 | 230 |
| 18MM | 222 | 318 |



WARNING

Failure to read and follow these instructions could result in separation of the towed vehicle from the tow bar, causing property damage, loss of towed vehicle, personal injury or death.

BX2628
2011-14 Ford Edge (Includes Adaptive Cruise Control)(No 2.0L EcoBoost AWD)
Installation Instructions

Instruction Notes: The fascia, headlights and windshield washer fluid reservoir are removed and reinstalled for the baseplate installation. Some drilling and trimming is required.

Place all components that are removed on a flat, sturdy surface. All items will be reinstalled unless otherwise noted after the baseplate is installed.

The dimensional variations between otherwise identical vehicles can be considerable. While the baseplate was designed for easy installation, it may be necessary to tailor the baseplate slightly to compensate for vehicle manufacturer's tolerances.

The BX8848 4-Diode Wiring Kit is recommended for this vehicle.

NOTICE

- Handling of some cosmetic parts when installing this product may require the use of protective covers, rags, specialty tools, etc. to prevent damage.
- When using power drills be aware of the dangers of torque and drill bit length.
- When using a reciprocating saw be aware of objects behind the cutting surface.
- Use a good quality paint to spray cut edges of frame to prevent rusting.
- Be sure that **ALL** electrical connections are plugged in and accessories are functioning properly before reinstalling the fascia.
- The baseplate is computer tested to your vehicle's GVWR, exceeding this weight will void the manufacturer's warranty.
- Be sure to use a sufficient amount of Loctite® Red on all bolt threads before tightening. Tighten all bolts according to the torque chart provided unless specified.
- Dealer or installer be certain the user receives these instruction sheets.
- If the baseplate is in an accident, it must be replaced. **DO NOT** use it again! An accident can cause unseen damage and using it again could result in more damage or serious injury. **DO NOT** use the baseplate if it is damaged or missing parts.

BX2628
2011-14 Ford Edge (Includes Adaptive Cruise Control)(No 2.0L EcoBoost AWD)
Installation Instructions

Tools Required

5.5MM Socket
Large Vise Grip
Drill
8MM Socket
Reciprocating Saw
Hammer
Floor Jack
10MM Socket
Phillips Screwdriver
1 1/4" Hole Saw
13MM Socket
Utility Knife
13/32" Drill Bit
9/16" Socket
Torque Wrench
17/32" Drill Bit
3/4" Socket
Tape Measure
Loctite® RED

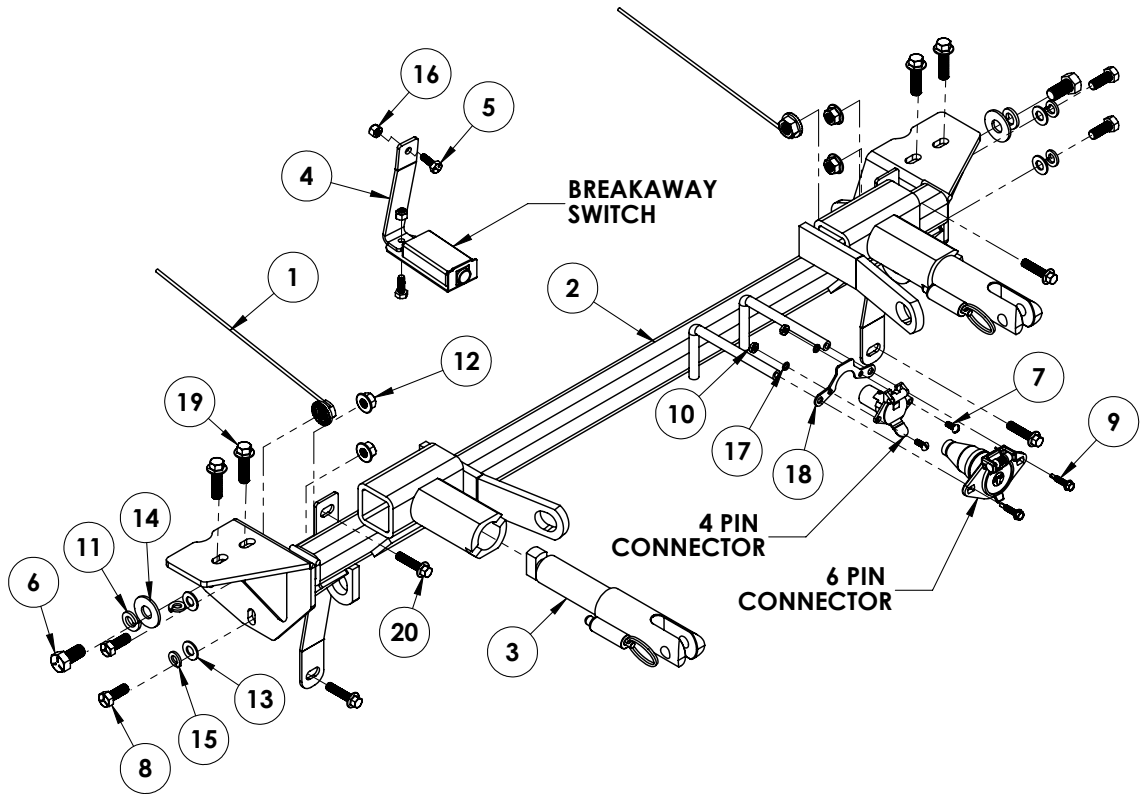

Parts List

| Ref. No. | Qty. | Part # | Description |
|----------|--------|---------------------------|---|
| 1..... | 2..... | 61-4029..... | 1/2"-13 Whiz Nut Weldment with 10" Wire |
| 2..... | 1..... | 61-6844..... | BX2628 Baseplate |
| 3..... | 2..... | 62-3469..... | Attachment Tab Assembly |
| 4..... | 1..... | 102-7256..... | BX1131 Breakaway Bracket |
| 5..... | 2..... | 201-0050..... | 1/4"-20 x 3/4" Hex Head Bolt, Grade 5, ZP |
| 6..... | 2..... | 201-0060..... | 1/2"-13 x 1" Hex Head Bolt, Grade 5, ZP |
| 7..... | 2..... | 201-0192..... | #10-32 1/2" Round Slotted Head Screw |
| 8..... | 4..... | 201-0443..... | 3/8"-16 x 1" Hex Head Bolt, Grade 5, ZP |
| 9..... | 2..... | 201-0979..... | #12-14 x 1" Self Drilling Screw, ZP |
| 10..... | 2..... | 202-0047..... | #10-32 Hex Nut |
| 11..... | 2..... | 203-0012..... | 1/2" Lock Washer, ZP |
| 12..... | 4..... | 202-0071..... | 3/8"-16 Hex Flange Nut, ZP |
| 13..... | 4..... | 203-0003..... | 3/8" Flat Washer, ZP |
| 14..... | 2..... | 203-0005..... | 1/2" Flat Washer, ZP |
| 15..... | 4..... | 203-0010..... | 3/8" Lock Washer, ZP |
| 16..... | 2..... | 202-0102..... | 1/4"-20 Hex Nut with Nylon Insert |
| 17..... | 2..... | 203-0054..... | #10 Lock Washer, ZP |
| 18..... | 1..... | 299-0685..... | Electrical Bracket, ZP |
| 19..... | 4..... | Existing Bolt..... | M10 x 1.5 x 35 Hex Flange Screw |
| 20..... | 4..... | Existing Bolt..... | M8 x 1.25 x 35 Hex Flange Screw |
| 21..... | 2..... | 226-0049 (not shown)..... | Class IV 36" Safety Cable |
| 22..... | 2..... | 229-0512 (not shown)..... | 1/2" Quicklink, ZP |
| 23..... | 2..... | 290-0437 (not shown)..... | Black Cap Plug Receiver |

Important:

Use only genuine factory replacement parts on your baseplate. Do **NOT** substitute homemade or non-typical parts. If a bolt is lost or in need of replacement, for your safety and the preservation of your baseplate, be sure to use a replacement bolt of the same grade (In most cases it will be Grade 5, please reference the parts list above). Replacement parts may be ordered through your nearest Blue Ox® Dealer or Distributor. Failing to follow and/or altering these installation instructions in either installation or required equipment will void the manufacturer's warranty.

2011-14 Ford Edge (Includes Adaptive Cruise Control)(No 2.0L EcoBoost AWD)
Installation Instructions



1. Using a Phillips screwdriver, remove two plastic Phillips push pins (see white arrows) and then using a 10MM socket, remove one bolt (see grey arrow) from the flat plastic piece on top. Do this to both sides of the vehicle. Set bolts and push pins aside to be reinstalled later.

2. Using a 5.5MM socket, remove three bolts just forward of the front tire on the wheel well. Do this to both sides of the vehicle. Set bolts aside to be reinstalled later.

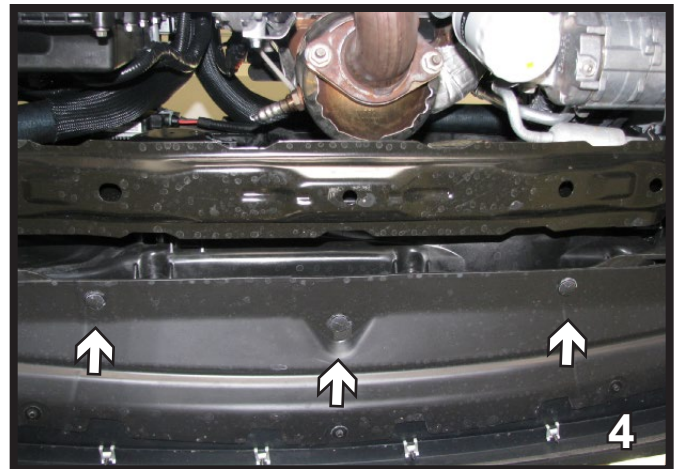
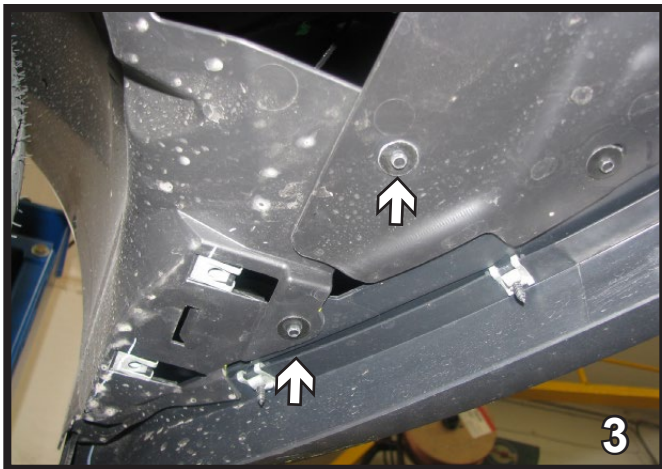

3. Using a 5.5MM socket, remove two bolts that are located underneath. Set bolts aside to be reinstalled later. Do this on both sides of the vehicle.

4. Using a flat screwdriver, remove three push pins across the middle. Set push pins aside to be reinstalled later. Pull the fascia up and out to remove from the vehicle and set aside carefully to be reinstalled later.

BX2628
2011-14 Ford Edge (Includes Adaptive Cruise Control)(No 2.0L EcoBoost AWD)
Installation Instructions

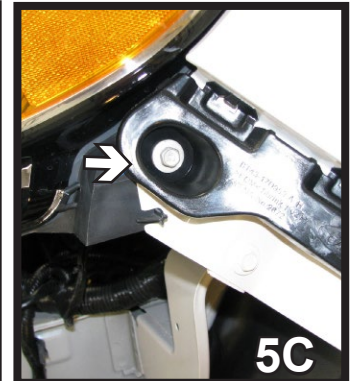
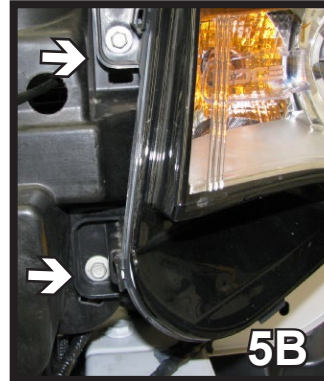

5. Using a 10MM socket, remove four bolts from the headlight assembly. Remove headlight by pulling it forward and disconnecting the electrical connections. Do this to both sides of the vehicle. Set headlight assemblies and bolts aside to be reinstalled later.

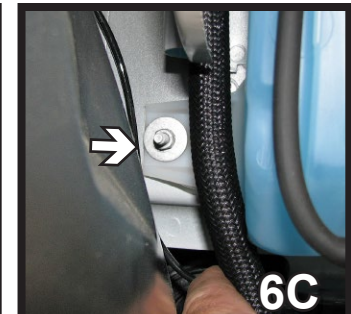
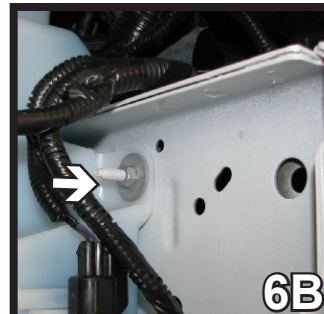
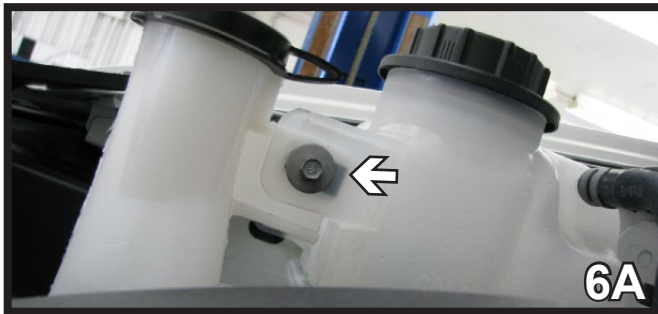

6. On the passenger side using an 8MM socket, remove one bolt from the top of the washer reservoir. Using a 10MM socket, remove two bolts one on each side. Disconnect the electrical connections and the hoses and remove the washer reservoir. Cap the fluid openings. Set the washer reservoir and bolts aside to be reinstalled later.

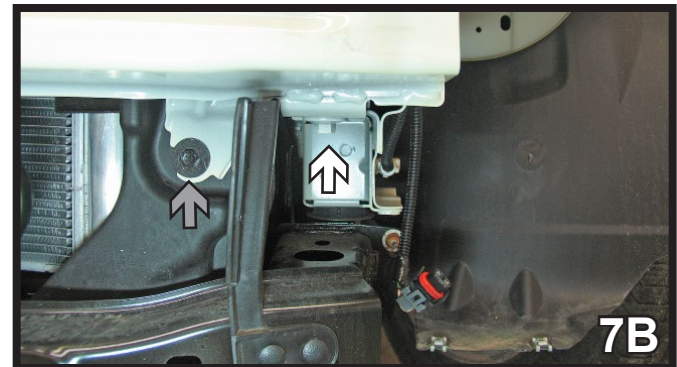
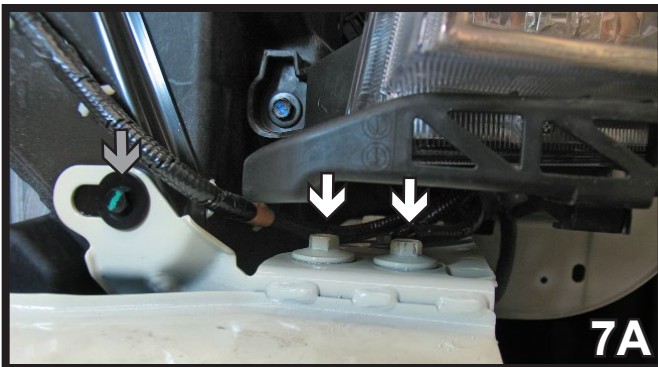

7. Using a 13MM socket, remove two bolts from the top of the metal bumper and one bolt from the bottom (see white arrows). Then using a 10MM socket, remove one bolt from the top of the bumper and one bolt from the bottom (see grey arrows). Do this to both sides of the vehicle. Set bolts aside to be reinstalled later and the metal bumper will not be reinstalled. NOTE: When bumper is removed, radiator cross member will fall down slightly and will need to be brought back up into position when installing the baseplate.

2011-14 Ford Edge (Includes Adaptive Cruise Control)(No 2.0L EcoBoost AWD)
Installation Instructions

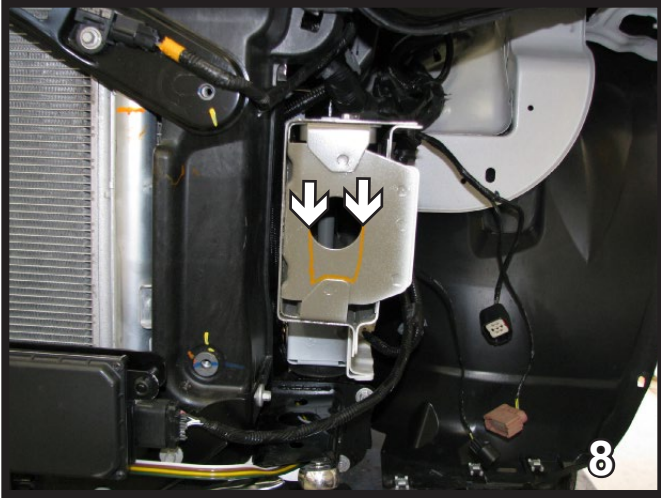

8. On the front of the frame, using a reciprocating saw, cut straight down on the dashed lines. Bend in across the bottom. Do this to both sides of the vehicle.

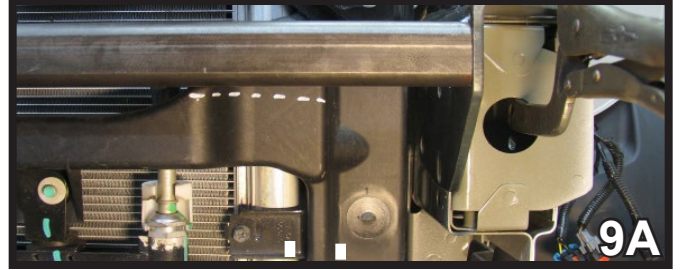

9. Some models may need to have this area trimmed. Set baseplate on top of frame and clamp into place with vise grips. You then need to take a marker and draw a line on the plastic piece below the tube (see photo 9A). Remove baseplate and using a reciprocating saw, trim away plastic area outlined in photo 9B. Do this to both sides of the vehicle. On the passenger side, be very careful not to damage the area behind.

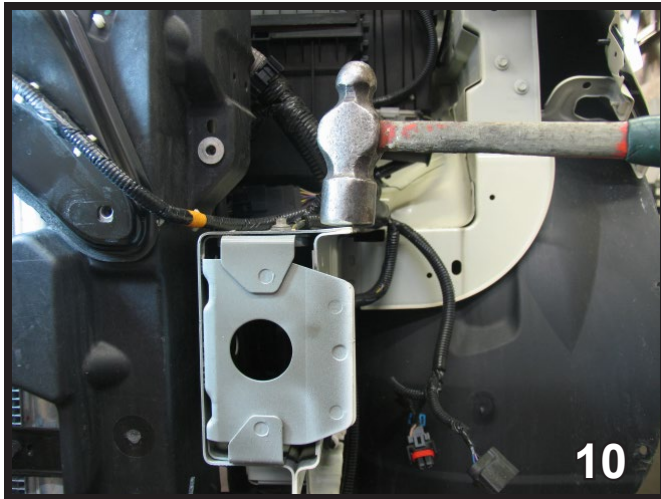

10. You will need to hit the top of the frame a couple times with a hammer to get it level. You can use a straight edge as a guide. Do this to both sides of the vehicle.

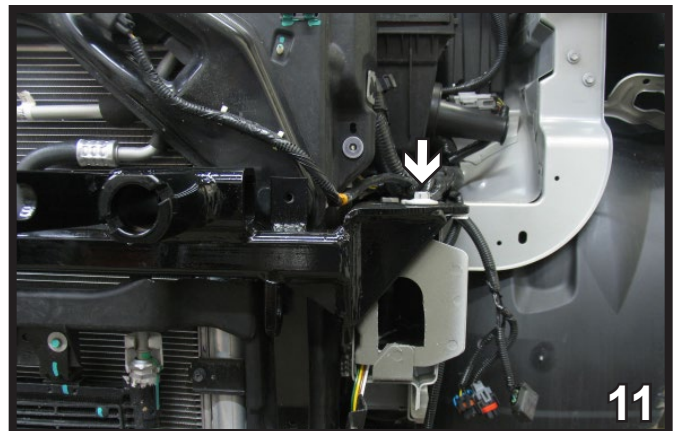

11. Place baseplate on top of frame and line up the holes in the baseplate with the existing holes on top of the frame. Insert one existing 13MM bolt removed in step 7, to hold baseplate into place. Do this to both sides of the vehicle. Use a floor jack to hold the radiator up in place.

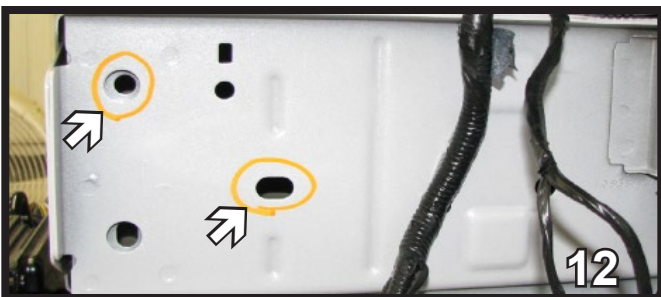

12. Using a 1 1/4" hole saw, drill two 1 1/4" holes into the frame, so an extension can be used to tighten up bolts. Do this to both sides of the vehicle.

When using power drills be aware of the dangers of torque and drill bit length.

2011-14 Ford Edge (Includes Adaptive Cruise Control)(No 2.0L EcoBoost AWD)
Installation Instructions

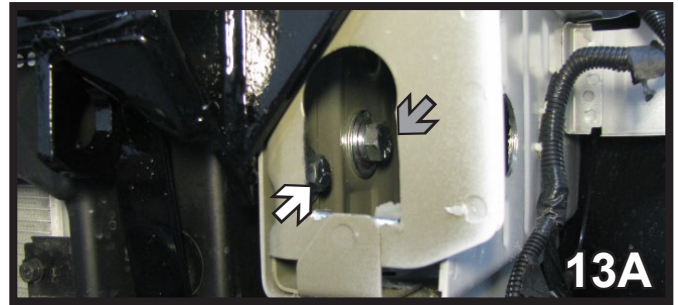
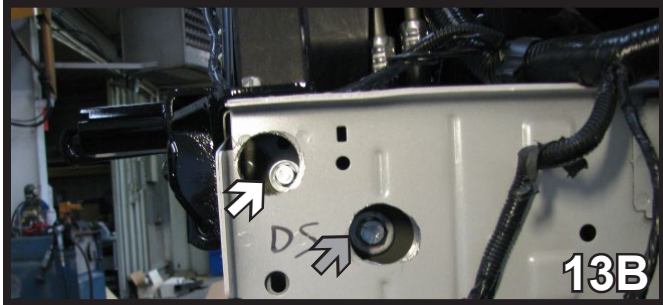

13. Using the baseplate as a template, insert 3/8-16x1" hex bolts with Loctite, 3/8" lock washers and 3/8" flat washers into the two outside holes and tighten down with a 3/8-16 hex flange whiz lock nuts (see white arrows). On the inside hole use a 1/2-13x1" hex bolt with Loctite, 1/2" lock washer and 1/2" flat washer tightened to a 1/2" wire nut inserted into the frame (see grey arrows). Do this to both sides.

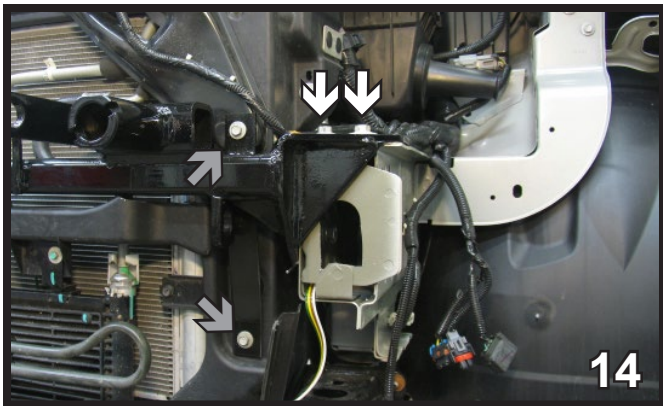

14. After the bolts in Step 13 are installed, you can reinstall the top two 13MM bolts (white arrows) removed in Step 7 and also the two 10MM bolts (gray arrows) removed in Step 7 to hold the radiator support back in place. Do this to both sides of the vehicle. (See note on Step 7.)

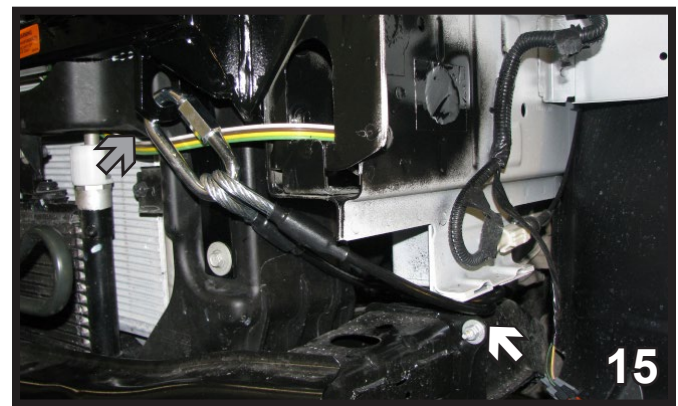

15. Attach the permanent baseplate safety cables to the provided convenience link on the baseplate (gray arrow). The photo above shows the recommended installation of the cables to frame of vehicle (white arrow). Additional options may interfere with suggested mounting; in this case secure the cables to a solid piece of the frame as described in the instructions included with the permanent baseplate safety cables. Be sure the safety cables do not rub against any hoses or moving parts. Do this to both sides of the vehicle.

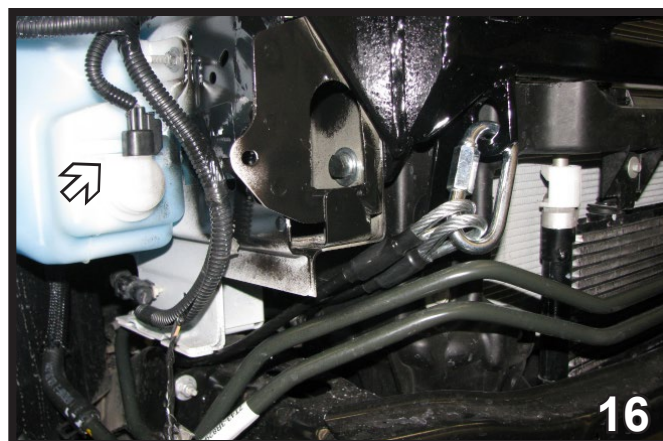

16. On the passenger side, reinstall the washer reservoir. Reconnect the electrical connections and the hoses.

17. Reinstall the headlight assemblies. Reconnect all electrical connections.

2011-14 Ford Edge (Includes Adaptive Cruise Control)(No 2.0L EcoBoost AWD)
Installation Instructions

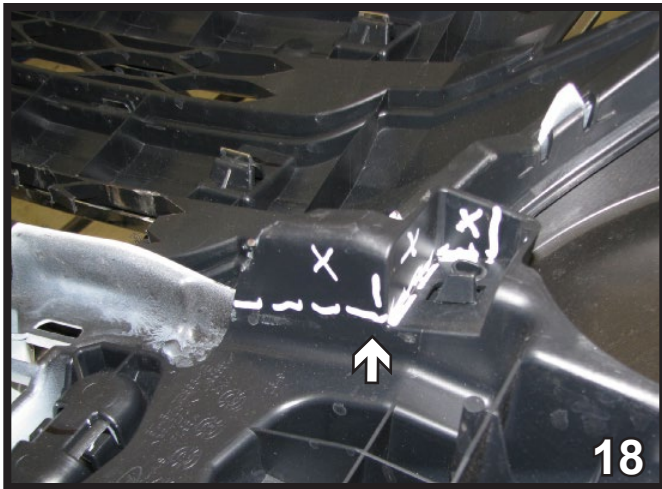

18. On the back side of the front fascia, using a reciprocating saw, trim the plastic as shown on the passenger side. Do this to both sides of the fascia.



19. Align the fascia to its original position and using a utility knife, trim grille area in front of the attachment tabs. This will then create an opening for the tabs to come through, when reinstalling the fascia. Do this to both sides of the vehicle.

CUSTOMER SERVICE COMMITMENT

Blue Ox® is committed to providing you with exceptional customer care throughout your lifetime with our products. Our team is here to assist you with any questions you may have regarding the performance of your product. Simply call (402) 385-3051 and you can speak with our technical service team.

Additionally, please visit our website to see which rallies our Destination America team will be attending. For a nominal fee, our service technician will service your towing system to ensure it's in proper working condition. Also, as a commitment to our customers, should you visit our factory, you can stay at our full service Blue Ox® campground at no charge along with enjoying a factory tour.

Again, thank you for being our customer and for the confidence you have shown in the performance of our products. It is because of customers like you we enjoy the success we have today.

© 2016 Blue Ox
One Mill Road, Industrial Park
Pender, Nebraska 68047
Phone: (402) 385-3051
Fax: (402) 385-3360
www.blueox.com

General Information

1. Ensure that your product(s) are registered online at www.blueox.com. It is crucial to register your product(s) so that you may be alerted of product offerings, updates, upgrades, maintenance and safety bulletins, and/or recalls.
2. **It is the owner's responsibility to inspect all towing equipment for cracked welds, missing or worn parts and loose bolts before each towing trip.** Be sure to use Loctite® Red on all bolts and tighten to the recommended specifications.
3. **It is the owner's responsibility to hook up all towing equipment per manufacturer's instructions/recommendations.**
4. Remove the attachment tabs when not in use (if applicable).

Notice To Baseplate Installer

1. It is YOUR responsibility to watch for:

- Oil cooler and air conditioner lines
- Electrical wires and hoses
- Missing parts or attaching points on the frame

** If the baseplate is improperly installed and is against a wire or hose, it could cause fluid leaks or electrical shorts some time after the actual baseplate installation.

Permanent Baseplate Safety Cable Installation

Permanent baseplate safety cables are strongly recommended when towing a vehicle with a tow bar. The principle function of the permanent baseplate safety cables is to prevent the towed vehicle from breaking loose in the event the connection between the frame of the towed vehicle and the baseplate fails or becomes disconnected. The cables must be connected from the baseplate to the frame rail or cross member of the vehicle's frame. The illustrations below show the possible arrangements recommended by Blue Ox®. Each permanent baseplate safety cable must have an adequate weight rating for the towing system. The weight rating of the two (2) cables together will not qualify.

Do not mount the permanent baseplate safety cables against wires, hoses or brake lines.

These permanent baseplate safety cables should remain installed as long as the baseplate is installed on the vehicle. Permanent baseplate safety cables are to be used in conjunction with, and NOT a replacement for legally required safety cables attaching the towed vehicle to the towing vehicle.

Option #1

(Baseplates with Convenience Link Tabs)



Option #2

(Baseplates with out Convenience Link Tabs)



BLUE OX ORIGINAL PURCHASERS THREE YEAR LIMITED WARRANTY

Automatic Equipment Manufacturing Company ("Automatic") warrants to the original (first) retail purchaser that this product, manufactured by Automatic, shall be free from defect in material and workmanship under normal use and service for a period of three years from the date of delivery.

During said three-year period, Automatic will repair or replace any parts that have been returned by the original purchaser, to the factory, transportation prepaid, and in Automatic's sole and absolute opinion found to be defective.

Limitations on Warranty Coverage:

Coverage under this warranty will be valid only if the customer warranty card is returned by the original purchaser within 30 days of purchase.

Coverage under this warranty will be effective only when a copy of the original invoice, showing date and place of purchase, accompanies any claim for warranty. This warranty is NON TRANSFERABLE.

This limited warranty will not cover, in any way or form, any alleged damages caused by incorrect or improper installation, improper use, modification or neglect of product, failure to properly service and maintain, misuse, act of God, accident or failure of the user to follow guidelines contained in the instructional material provided by Automatic.

This warranty does not cover normal wear and tear, paint or rust.

Warrantor assumes no responsibility to the owner for loss of use of product, loss of time, inconvenience or any other damage consequential or otherwise. Including, but not limited to mileage, expense of transporting of product, return shipping expense, mechanics travel time, telephone, road service, towing, and rental during repairs, travel, lodging, loss or damage to personal property or loss of earnings.

REPAIR OR REPLACEMENT AS SET FORTH IN THIS LIMITED WARRANTY IS THE SOLE EXCLUSIVE REMEDY OF THE PURCHASER. AUTOMATIC SHALL NOT BE LIABLE FOR ANY INCIDENTAL OR CONSEQUENTIAL DAMAGES FOR BREACH OF ANY EXPRESS OR IMPLIED WARRANTY ON THIS PRODUCT. EXCEPT TO THE EXTENT PROHIBITED BY APPLICABLE LAW, ANY IMPLIED WARRANTY OF MERCHANTABILITY OR FITNESS FOR A PARTICULAR PURPOSE ON THIS PRODUCT IS LIMITED IN LENGTH TO THE DURATION OF THIS WARRANTY.

Please visit <http://blueox.com/warranty/> to register your warranty

